



Updated pricing effective  
7-1-2022

labelworks®

Powered by Navitor

2022

# TABLE OF CONTENTS

How To Order FasTurn® Labels ..... 1a



FasTurn® Most Popular Labels ..... 1 - 2



FasTurn® Labels

Rectangles ..... 3 - 6  
Squares ..... 5 - 6  
Circles, Bursts & Ovals ..... 7 - 8  
Special Shapes ..... 9  
Square Cut ..... 10

Foil Stamped and/or Embossed ..... 11 - 12



Special Effects Labels ..... 13 - 14



Unique Application Labels

Beer Labels ..... 15  
Wine Labels ..... 16  
Water Bottle Labels ..... 17  
 Safety Seal ..... 18  
Tech Decal Sheets ..... 19  
Bumper Stickers ..... 20  
Specialty Application Labels ..... 21



freeform™ Laser Cut Labels

Label Sheets ..... 22  
Laser Cut Labels ..... 23  
Outdoor Labels ..... 24



Repositionable Window Decals ..... 25 - 26



Outdoor Labels

Rectangles & Squares ..... 27 - 28  
Ovals & Circles ..... 29  
Square Cut ..... 30

Reflective Labels ..... 31

Asset Labels ..... 32

Computer Labels

Pinfed Labels ..... 33  
Laser Sheets ..... 34

Designer Mailing Labels ..... 35 - 36



Packaging Solutions ..... 37 - 38

General Information

Variable Printing & Consecutive Numbering ..... 39  
Barcodes ..... 40  
Stock Reference Guide ..... 41 - 42  
Glossary ..... 43 - 44  
Guidelines & Artwork Information ..... 45  
Machine Applied Labels ..... Inside Back Cover

# Welcome!



## HOW TO ORDER 24 HOUR FASTURN® LABELS

### 1. Select shape and size

Choose from hundreds of stock sizes from pages 1-9

### 2. Select ink color(s)

• **Standard Inks** -Price includes one ink; PMS inks \$50.00 (V) each. Additional ink(s) charge on price grids

For clear stocks, white back-up is recommended; add add'l ink charge

Navy Blue PMS 281	Reflex Blue Pantone® Reflex Blue	Light Blue Pantone® Process Blue	Teal PMS 327	Dark Green PMS 357	Green PMS 347	Yellow Pantone® Process Yellow	Orange PMS 021	Red PMS 185	Burgundy PMS 208	Pink PMS 219	Light Pink PMS 203	Purple Pantone® Purple	Violet Pantone® Violet
Brown PMS 469	Black	Grey PMS 424	White	UV Matte Varnish	UV Gloss* Varnish	<i>*Not recommended for matte stocks</i>							

• **Process Color**

• **Foil Stamping and/or Embossing** please see pages 13 - 14

#### PLEASE NOTE

- The PMS ink colors are approximate and are listed for reference only.
- Process Color labels will use a close CMYK representation of these inks.
- If color is critical, Pantone® color matches are available for \$50(V) per ink.

### 3. Select stock

• **24 Hour FasTurn® 1 Color Stocks** pages 1 - 12

<b>Gloss</b>					<b>Matte</b>					
A White Gloss	Q White Gloss Blockout	AS White Gloss Removable	BC Ivory Gloss	B Yellow Gloss	G White Matte	R White Matte Blockout	BF White Matte Removable	BH Ivory Matte	AM Yellow Matte	H White EDP
<b>Recycled</b>		<b>Foil</b>			<b>Film / BOPP</b>			<b>Premium</b>		
TR 30% Recycled Semi-Gloss	D Gold Foil	E Silver Foil	AI Gold Foil Dull	AH Silver Foil Dull	WB White Film BOPP	BJ* Clear Film BOPP	KR Silver Film BOPP	BW Brown Kraft	SW Estate #8	ET Estate #9
<i>*White ink back-up is recommended on Clear Film BOPP (BJ) for readability</i>										
<i>Please add a 25% upcharge to all Premium stock orders</i>										
<b>Fluorescent</b>										
I Fluorescent Green	AE Fluorescent Orange	AF Fluorescent Pink	AG Fluorescent Chartreuse	C Fluorescent Red						

• **24 Hour FasTurn® Process Color Stocks** pages 1 - 12

<b>Gloss</b>			<b>Matte</b>		<b>Recycled</b>	<b>Film / BOPP</b>		
A White Gloss	Q White Gloss Blockout	AS White Gloss Removable	G White Matte	BF White Matte Removable	TR 30% Recycled Semi-Gloss	WB White Film BOPP	BJ* Clear Film BOPP	KR Silver Film BOPP
<b>Foil</b>		<b>Premium</b>			<i>*White ink back-up is recommended on Clear Film BOPP (BJ) for readability</i>			
E Silver Foil	AH Silver Foil Dull	BW Brown Kraft	SW Estate #8	ET Estate #9	<i>Please add a 25% upcharge to all Premium stock orders</i>			

### Quick tips to make your Label stand out and make an impact:

Create an eye-catching label by matching the perfect ink with the appropriate stock.

- Please call if you need a sample swatch of a specific stock.
- Black ink is recommended on fluorescent stocks.
- Metallic inks available, just price them as a PMS ink at \$50.00(V) each.
- Create your own stock color! Flood coat stock with an ink color of your choice.
- We have more stocks available, call us to discuss.



CHECK IT OUT

Our best sellers available at low prices, a quick turn-time and your choice of high-quality spot color or process color imprint!

24-Hour FasTurn® Most Popular Labels

SIZE	DIE	GROUP	SHAPE
1/2" x 1"	102	A	Rectangle
1/2" x 1 1/2"	1312	A	Rectangle
1/2" x 2"	107	A	Rectangle
1/2" x 2 1/2"	1953	B	Rectangle
3/4" x 1"	1280	A	Rectangle
3/4" x 1 1/2"	108	A	Rectangle
3/4" x 1 3/4"	10241	B	Rectangle
3/4" x 2"	109	B	Rectangle
7/8" x 3"	1256	C	Rectangle
1" x 1 1/2"	140	B	Rectangle
1" x 1 3/4"	9586	B	Rectangle
1" x 2"	155	B	Rectangle
1" x 2 1/2"	110	C	Rectangle
1" x 3"	1242	C	Rectangle
1 1/4" x 2"	181	C	Rectangle
1 1/4" x 3 1/2"	1258	F	Rectangle
1 1/2" x 1 3/4"	176	C	Rectangle
1 1/2" x 2"	113	C	Rectangle
1 1/2" x 2 1/4"	1224	D	Rectangle
1 1/2" x 2 1/2"	195	E	Rectangle
1 1/2" x 3"	148	F	Rectangle
1 3/4" x 2 3/4"	142	F	Rectangle
2" x 3"	145	G	Rectangle
2" x 3 1/2"	123	H	Rectangle
2" x 4"	127	H	Rectangle
2 7/8" x 5"	115	K	Rectangle
2 15/16" x 4"	114	J	Rectangle
3" x 4"	1212	J	Rectangle
3" x 5"	1213	K	Rectangle
4" x 5"	1314	L	Rectangle
4" x 6"	185	M	Rectangle
1" x 1"	250	A	Square
1 1/2" x 1 1/2"	201	C	Square
2" x 2"	202	E	Square
2 1/2" x 2 1/2"	204	G	Square
3" x 3"	203	I	Square
4" x 4"	205	K	Square
1 1/4" x 2 1/2"	357	D	Oval
1 5/8" x 3"	302	F	Oval
2" x 3"	323	G	Oval
4" x 6"	358	M	Oval
1"	402	A	Circle
1 1/2"	424	C	Circle
2"	440	E	Circle
2 1/2"	401	G	Circle
3"	459	I	Circle
1 7/8"	523	E	Burst



Quick tips to make your label stand out and make an impact:

- These popular shapes and sizes are a fit for any market!
- Expanded offering of our most in demand shapes and sizes can be found on **page 1a**.
- For ink and 24-Hour FasTurn® stock choices, **see page 1a**.
- Labels are provided on rolls. If individually cut labels are wanted, add a \$35.00 (V) cutting charge per order.
  - Minimum size is 2" x 2"
- Rectangles and squares have rounded corners with a 1/8" (0.125") radius.
- Process Color labels include **FREE** UV varnish for added protection against scratching and light moisture.
  - For UV varnish on 1-color labels, please price as an additional ink.



1 Color 24-Hour FasTurn® Most Popular

Additional ink charges at bottom of price grid.

GROUP	250	500	1,000	2,000	3,000	5,000	10,000	15,000	20,000	25,000
A	\$75.06	\$78.30	\$99.90	\$85.86/m	\$76.14/m	\$55.08/m	\$37.80/m	\$32.40/m	\$28.08/m	\$25.92/m
B	\$78.30	\$83.70	\$103.14	\$90.18/m	\$78.30/m	\$58.32/m	\$41.58/m	\$35.64/m	\$32.40/m	\$30.78/m
C	\$86.40	\$89.64	\$113.40	\$96.12/m	\$88.56/m	\$66.96/m	\$50.76/m	\$43.74/m	\$39.96/m	\$37.26/m
D	\$89.64	\$93.96	\$117.18	\$103.68/m	\$91.26/m	\$70.74/m	\$54.00/m	\$48.06/m	\$42.66/m	\$39.42/m
E	\$93.96	\$97.20	\$117.72	\$107.46/m	\$95.58/m	\$78.30/m	\$56.16/m	\$49.14/m	\$43.74/m	\$41.04/m
F	\$99.36	\$101.52	\$125.82	\$110.70/m	\$99.90/m	\$81.00/m	\$58.32/m	\$50.22/m	\$44.82/m	\$41.58/m
G	\$100.44	\$105.30	\$129.60	\$112.32/m	\$102.60/m	\$82.62/m	\$61.02/m	\$52.92/m	\$48.60/m	\$46.44/m
H	\$105.30	\$109.62	\$131.76	\$116.10/m	\$103.68/m	\$85.86/m	\$63.18/m	\$55.08/m	\$50.76/m	\$48.06/m
I	\$110.70	\$117.72	\$144.72	\$129.60/m	\$113.40/m	\$96.12/m	\$74.52/m	\$64.80/m	\$57.78/m	\$53.46/m
J	\$119.88	\$126.90	\$153.90	\$143.10/m	\$123.12/m	\$102.06/m	\$85.86/m	\$71.82/m	\$64.80/m	\$60.48/m
K	\$139.86	\$146.88	\$184.14	\$157.68/m	\$131.76/m	\$108.00/m	\$89.10/m	\$76.68/m	\$69.12/m	\$64.26/m
L	\$171.72	\$180.36	\$223.56	\$202.50/m	\$173.34/m	\$135.00/m	\$103.68/m	\$94.50/m	\$90.72/m	\$82.08/m
M	\$236.52	\$248.40	\$304.02	\$261.90/m	\$211.68/m	\$160.92/m	\$130.14/m	\$116.10/m	\$112.32/m	\$105.30/m
Each Add'l Ink	\$54.00	\$54.00	\$54.00	\$32.50/m	\$22.50/m	\$16.50/m	\$11.50/m	\$9.50/m	\$8.50/m	\$7.50/m

Premium Stocks: Add 25% upcharge to base price for ALL quantities

(P) Prices effective January 1, 2022. Maximum of 3 colors

To ensure 24-Hour production, please submit print-ready artwork by 2:00 pm CT to ship the following day. UV varnish is not included in 1-Color printing. If wanted, price as an additional ink.

Process Color Pricing • SHIPS IN 24-HOURS!

GROUP	100	250	500	1,000	2,000	3,000	5,000	10,000
A, B, C, D, E	\$264.60	\$278.64	\$310.50	\$446.58	\$284.58/m	\$212.22/m	\$169.56/m	\$118.26/m
F, G	\$297.00	\$310.50	\$389.34	\$509.22	\$349.38/m	\$282.96/m	\$222.48/m	\$137.16/m
H, I	\$314.28	\$332.10	\$409.32	\$559.98	\$387.18/m	\$308.34/m	\$244.62/m	\$159.84/m
J, K	\$334.26	\$350.46	\$413.64	\$572.94	\$403.38/m	\$321.30/m	\$257.04/m	\$182.52/m
L	\$361.26	\$376.38	\$453.06	\$618.84	\$419.58/m	\$346.14/m	\$315.90/m	\$237.06/m
M	\$441.18	\$461.70	\$506.52	\$682.56	\$487.08/m	\$385.56/m	\$340.20/m	\$294.30/m

Premium Stocks: Add 25% upcharge to base price for ALL quantities

(P) Prices effective January 1, 2022. Provide print-ready file (EPS, PDF); sized to chosen label.

To ensure 24-Hour production, please submit print-ready artwork by 2:00 pm CT to ship the following day. UV varnish is applied at no additional cost. Process Color inks are not fade-resistant.



# RECTANGLES



**Quick tips to make your label stand out and make an impact:**

- For ink and 24-Hour FasTurn® stock choices, see page 1a.
- Corner radius is 1/8" (0.125").
- Horizontal and vertical label orientations are available! Pick the option that best displays your design.



Can't find your size in our standard offering? Check out our expanded Most Popular offering on pages 1-2.

## 24-Hour FasTurn® Rectangles

SIZE	DIE	GROUP
3/8" x 1"	117	A
3/8" x 1 1/2"	190	A
1/2" x 1 3/8"	101	A
5/8" x 2"	170	B
5/8" x 2 1/4"	1237	B
3/4" x 2 1/2"	1238	B
3/4" x 2 3/4"	193	C
3/4" x 5 1/2"	153	E
7/8" x 1 3/4"	189	B
7/8" x 2"	124	B
7/8" x 4"	173	E
15/16" x 2 1/2"	130	C
15/16" x 3"	126	C
15/16" x 3 1/2"	161	D
1" x 2 5/8"	1252	C
1" x 3 1/4"	158	D
1" x 3 1/2"	103	E
1" x 4"	1214	E
1 1/4" x 1 3/4"	11567	B
1 1/8" x 3 1/8"	162	E
1 1/8" x 7 1/2"	135	H
1 1/4" x 2 5/8"	165	D
1 1/4" x 3"	156	E
1 3/8" x 3 1/2"	1240	F
1 3/8" x 4 1/4"	119	G
1 1/2" x 2 3/4"	1270	E
1 1/2" x 3 1/2"	143	G
1 1/2" x 5"	1246	H
1 5/8" x 2"	157	D
1 3/4" x 3"	121	G
1 3/4" x 3 1/4"	112	G
1 3/4" x 5"	1236	H
1 7/8" x 3"	152	G

Looking for a unique size or shape? See pages 22-24 for our freeform™ laser cut labels.





## 1 Color 24-Hour FasTurn® Rectangles

Additional ink charges at bottom of price grid.

GROUP	250	500	1,000	2,000	3,000	5,000	10,000	15,000	20,000	25,000
A	\$78.30	\$82.08	\$104.22	\$89.10/m	\$78.84/m	\$57.78/m	\$39.42/m	\$33.48/m	\$27.54/m	\$27.00/m
B	\$82.08	\$86.94	\$106.92	\$93.96/m	\$81.00/m	\$60.48/m	\$43.20/m	\$37.26/m	\$33.48/m	\$31.86/m
C	\$89.64	\$93.42	\$118.26	\$100.44/m	\$91.80/m	\$70.20/m	\$52.92/m	\$45.36/m	\$41.58/m	\$38.88/m
D	\$93.42	\$97.20	\$121.50	\$107.46/m	\$95.04/m	\$73.44/m	\$56.16/m	\$49.68/m	\$44.28/m	\$41.58/m
E	\$97.20	\$100.44	\$122.04	\$111.78/m	\$99.90/m	\$81.54/m	\$58.86/m	\$50.76/m	\$45.36/m	\$42.66/m
F	\$103.68	\$105.84	\$130.68	\$115.02/m	\$103.68/m	\$84.24/m	\$60.48/m	\$52.38/m	\$46.44/m	\$43.20/m
G	\$104.76	\$109.08	\$134.46	\$117.18/m	\$106.92/m	\$85.86/m	\$63.72/m	\$55.08/m	\$50.76/m	\$48.06/m
H	\$109.08	\$114.48	\$137.70	\$120.42/m	\$108.00/m	\$89.10/m	\$65.88/m	\$57.78/m	\$52.92/m	\$49.68/m
Each Add'l Ink	\$54.00	\$54.00	\$54.00	\$32.50/m	\$22.50/m	\$16.50/m	\$11.50/m	\$9.50/m	\$8.50/m	\$7.50/m

**Premium Stocks: Add 25% upcharge to base price for ALL quantities**

(P) Prices effective January 1, 2022.  
Maximum of 3 colors

To ensure 24-Hour production, please submit print-ready artwork by 2pm CT to ship the following day.  
UV Varnish is not included in 1 Color printing; if wanted, add as an additional ink.

## Process Color Pricing • SHIPS IN 24-HOURS!

GROUP	100	250	500	1,000	2,000	3,000	5,000	10,000
A, B, C, D, E	\$331.02	\$347.76	\$385.02	\$518.94	\$305.64/m	\$234.36/m	\$176.58/m	\$123.12/m
F, G	\$371.52	\$391.50	\$488.70	\$593.46	\$378.54/m	\$304.02/m	\$231.12/m	\$142.56/m
H	\$394.20	\$416.34	\$514.08	\$641.52	\$406.08/m	\$325.08/m	\$254.34/m	\$165.78/m

**Premium Stocks: Add 25% upcharge to base price for ALL quantities**

(P) Prices effective January 1, 2022.  
Provide print-ready file (EPS, PDF); sized to chosen label.

To ensure 24-Hour production, please submit print-ready artwork by 2pm CT to ship the following day.  
UV Varnish is applied at no additional cost. Process Color inks are not fade-resistant.



# RECTANGLES & SQUARES



**Quick tips to make your label stand out and make an impact:**

- For ink and 24-Hour FasTurn® stock choices, see page 1a.
- Corner radius is 1/8" (0.125").
- Horizontal and vertical label orientations are available! Pick the option that best displays your design.



Can't find your size in our standard offering? Check out our expanded Most Popular offering on pages 1-2.

## 24-Hour FasTurn® Rectangles

SIZE	DIE	GROUP
1 15/16" x 2 3/4"	139	G
1 15/16" x 3 1/2"	159	H
2" x 2 1/2"	151	F
2" x 3 1/4"	1946	H
2" x 4 1/2"	1461	I
2" x 5"	10629	I
2" x 6"	1243	J
2 1/4" x 4"	166	I
2 1/2" x 3"	116	H
2 1/2" x 3 1/2"	160	H
2 1/2" x 4"	1204	I
2 1/2" x 4 1/2"	10545	I
2 1/2" x 5"	1257	J
2 3/4" x 3 3/4"	171	I
2 7/8" x 4"	104	I
2 7/8" x 4 1/4"	122	J
2 15/16" x 4 1/4"	141	J
3" x 3 1/2"	1250	J
3" x 5 1/2"	8543	K
3" x 6"	9083	L
3" x 8"	10048	M
3 1/4" x 5"	1201	K
3 3/8" x 5"	175	K
3 3/8" x 5 1/2"	125	L
3 3/8" x 6"	106	L
3 1/2" x 4"	9745	J
3 1/2" x 4 1/2"	1232	K
3 7/8" x 4"	177	K
3 7/8" x 5"	134	L
3 7/8" x 5 1/4"	105	L
3 15/16" x 6"	150	M
4" x 5 1/2"	10509	L



## 24-Hour FasTurn® Squares

SIZE	DIE	GROUP
1 3/4" x 1 3/4"	255	D
2 3/4" x 2 3/4"	228	H
3 1/2" x 3 1/2"	254	J
5" x 5"	8554	M

Looking for a unique size or shape? See pages 22-24 for our freeform™ laser cut labels.





## 1 Color 24-Hour FasTurn® Rectangles

Additional ink charges at bottom of price grid.

GROUP	250	500	1,000	2,000	3,000	5,000	10,000	15,000	20,000	25,000
D	\$93.42	\$97.20	\$121.50	\$107.46/m	\$95.04/m	\$73.44/m	\$56.16/m	\$49.68/m	\$44.28/m	\$41.58/m
F	\$103.68	\$105.84	\$130.68	\$115.02/m	\$103.68/m	\$84.24/m	\$60.48/m	\$52.38/m	\$46.44/m	\$43.20/m
G	\$104.76	\$109.08	\$134.46	\$117.18/m	\$106.92/m	\$85.86/m	\$63.72/m	\$55.08/m	\$50.76/m	\$48.06/m
H	\$109.08	\$114.48	\$137.70	\$120.42/m	\$108.00/m	\$89.10/m	\$65.88/m	\$57.78/m	\$52.92/m	\$49.68/m
I	\$115.56	\$122.04	\$150.66	\$135.54/m	\$118.26/m	\$100.44/m	\$77.22/m	\$67.50/m	\$59.94/m	\$55.62/m
J	\$124.20	\$131.76	\$159.84	\$148.50/m	\$127.98/m	\$106.38/m	\$89.10/m	\$75.06/m	\$66.96/m	\$62.64/m
K	\$145.26	\$152.82	\$191.16	\$164.16/m	\$136.62/m	\$112.32/m	\$92.88/m	\$79.38/m	\$71.82/m	\$66.96/m
L	\$213.84	\$225.18	\$279.18	\$225.72/m	\$179.82/m	\$140.40/m	\$107.46/m	\$95.58/m	\$89.10/m	\$85.32/m
M	\$283.50	\$298.08	\$365.58	\$302.94/m	\$253.80/m	\$192.78/m	\$146.34/m	\$130.14/m	\$117.72/m	\$110.16/m
Each Add'l Ink	\$54.00	\$54.00	\$54.00	\$32.50/m	\$22.50/m	\$16.50/m	\$11.50/m	\$9.50/m	\$8.50/m	\$7.50/m

**Premium Stocks: Add 25% upcharge to base price for ALL quantities**

(P) Prices effective January 1, 2022.  
Maximum of 3 colors

To ensure 24-Hour production, please submit print-ready artwork by 2pm CT to ship the following day.  
UV Varnish is not included in 1 Color printing; if wanted, add as an additional ink.

## Process Color Pricing • SHIPS IN 24-HOURS!

GROUP	100	250	500	1,000	2,000	3,000	5,000	10,000
D	\$331.02	\$347.76	\$385.02	\$518.94	\$305.64/m	\$234.36/m	\$176.58/m	\$123.12/m
F, G	\$371.52	\$391.50	\$488.70	\$593.46	\$378.54/m	\$304.02/m	\$231.12/m	\$142.56/m
H, I	\$394.20	\$416.34	\$514.08	\$641.52	\$406.08/m	\$325.08/m	\$254.34/m	\$165.78/m
J, K	\$419.04	\$439.56	\$518.94	\$665.82	\$428.76/m	\$345.60/m	\$267.30/m	\$189.54/m
L	\$523.80	\$549.18	\$671.76	\$842.94	\$517.86/m	\$400.14/m	\$305.10/m	\$228.96/m
M	\$639.36	\$673.92	\$750.60	\$928.80	\$600.48/m	\$483.84/m	\$376.38/m	\$284.58/m

**Premium Stocks: Add 25% upcharge to base price for ALL quantities**

(P) Prices effective January 1, 2022.  
Provide print-ready file (EPS, PDF); sized to chosen label.

To ensure 24-Hour production, please submit print-ready artwork by 2pm CT to ship the following day.  
UV Varnish is applied at no additional cost. Process Color inks are not fade-resistant.



# CIRCLES, BURSTS & OVALS



**Quick tips to make your label stand out and make an impact:**

- For ink and 24-Hour FasTurn® stock choices, see page 1a.
- Use a burst shape to make the message stand out with callouts and action items. The zig-zag label design is definitely an attention-grabber!
- Some people have a way with words. Others use words in a new way. Create impact by angling or making a border with your text.
- The oval, the quirky and elongated cousin to the oh-so-perfect circle, provides ample text space while maintaining that round, fluid elegance. Win-win!



Can't find your size in our standard offering? Check out our expanded Most popular offering on pages 1-2.

## 24-Hour FasTurn® Circles

SIZE	DIE	GROUP
1/2"	417	A
3/4"	443	A
1 1/8"	439	B
1 1/4"	435	B
1 3/8"	430	B
1 3/4"	407	D
2 1/8"	444	F
2 1/4"	404	F
2 3/4"	469	H
3 1/4"	8752	I
3 1/2"	460	J
4"	432	K
5"	468	M
5 1/4"	433	M
6"	465	M



## 24-Hour FasTurn® Bursts

SIZE	DIE	GROUP
1 1/4"	510	B
2"	11221	E
2 1/4"	524	F

## 24-Hour FasTurn® Ovals

SIZE	DIE	GROUP
3/4" x 1 1/2"	342	A
1" x 2"	308	B
1" x 1 3/4"	2023	B
1 1/4" x 2"	360	C
1 3/8" x 2 1/2"	309	D
1 1/2" x 2"	301	C
1 1/2" x 2 1/2"	359	D
1 11/16" x 2 1/2"	316	F
2" x 4"	362	H
2 7/8" x 3 3/4"	303	I
3" x 4"	371	J

Looking for a unique size or shape? See pages 22-24 for our freeform™ laser cut labels.





# CIRCLES, BURSTS & OVALS

24-HOUR FasTurn® LABELS



## 1 Color 24-Hour FasTurn® Circles, Bursts & Ovals

Additional ink charges at bottom of price grid.

GROUP	250	500	1,000	2,000	3,000	5,000	10,000	15,000	20,000	25,000
A	\$78.30	\$82.08	\$104.22	\$89.10/m	\$78.84/m	\$57.78/m	\$39.42/m	\$33.48/m	\$27.54/m	\$27.00/m
B	\$82.08	\$86.94	\$106.92	\$93.96/m	\$81.00/m	\$60.48/m	\$43.20/m	\$37.26/m	\$33.48/m	\$31.86/m
C	\$89.64	\$93.42	\$118.26	\$100.44/m	\$91.80/m	\$70.20/m	\$52.92/m	\$45.36/m	\$41.58/m	\$38.88/m
D	\$93.42	\$97.20	\$121.50	\$107.46/m	\$95.04/m	\$73.44/m	\$56.16/m	\$49.68/m	\$44.28/m	\$41.58/m
E	\$97.20	\$100.44	\$122.04	\$111.78/m	\$99.90/m	\$81.54/m	\$58.86/m	\$50.76/m	\$45.36/m	\$42.66/m
F	\$103.68	\$105.84	\$130.68	\$115.02/m	\$103.68/m	\$84.24/m	\$60.48/m	\$52.38/m	\$46.44/m	\$43.20/m
H	\$109.08	\$114.48	\$137.70	\$120.42/m	\$108.00/m	\$89.10/m	\$65.88/m	\$57.78/m	\$52.92/m	\$49.68/m
I	\$115.56	\$122.04	\$150.66	\$135.54/m	\$118.26/m	\$100.44/m	\$77.22/m	\$67.50/m	\$59.94/m	\$55.62/m
J	\$124.20	\$131.76	\$159.84	\$148.50/m	\$127.98/m	\$106.38/m	\$89.10/m	\$75.06/m	\$66.96/m	\$62.64/m
K	\$145.26	\$152.82	\$191.16	\$164.16/m	\$136.62/m	\$112.32/m	\$92.88/m	\$79.38/m	\$71.82/m	\$66.96/m
M	\$283.50	\$298.08	\$365.58	\$302.94/m	\$253.80/m	\$192.78/m	\$146.34/m	\$130.14/m	\$117.72/m	\$110.16/m
Each Add'l Ink	\$54.00	\$54.00	\$54.00	\$32.50/m	\$22.50/m	\$16.50/m	\$11.50/m	\$9.50/m	\$8.50/m	\$7.50/m

**Premium Stocks: Add 25% upcharge to base price for ALL quantities**

(P) Prices effective January 1, 2022.  
Maximum of 3 colors

To ensure 24-Hour production, please submit print-ready artwork by 2pm CT to ship the following day.  
UV Varnish is not included in 1 Color printing; if wanted, add as an additional ink.

## Process Color Pricing • SHIPS IN 24-HOURS!

GROUP	100	250	500	1,000	2,000	3,000	5,000	10,000
A, B, C, D, E	\$331.02	\$347.76	\$385.02	\$518.94	\$305.64/m	\$234.36/m	\$176.58/m	\$123.12/m
F, G	\$371.52	\$391.50	\$488.70	\$593.46	\$378.54/m	\$304.02/m	\$231.12/m	\$142.56/m
H, I	\$394.20	\$416.34	\$514.08	\$641.52	\$406.08/m	\$325.08/m	\$254.34/m	\$165.78/m
J, K	\$419.04	\$439.56	\$518.94	\$665.82	\$428.76/m	\$345.60/m	\$267.30/m	\$189.54/m
M	\$639.36	\$673.92	\$750.60	\$928.80	\$600.48/m	\$483.84/m	\$376.38/m	\$284.58/m

**Premium Stocks: Add 25% upcharge to base price for ALL quantities**

(P) Prices effective January 1, 2022.  
Provide print-ready file (EPS, PDF); sized to chosen label.

To ensure 24-Hour production, please submit print-ready artwork by 2pm CT to ship the following day.  
UV Varnish is applied at no additional cost. Process Color inks are not fade-resistant.

# SPECIAL SHAPES



## Quick tips to make your Label stand out and make an impact:

- For ink and 24-Hour FasTurn® stock choices, see page 1a.
- Ideal for recognition, awareness programs and anniversaries.
- Not seeing the shape you need? We have more stock shapes, designs and templates available. Contact us for the full variety or to discuss the specific shape you have in mind.
- Or create a custom shape with our laser cut freeform™ labels, see pages 22-24.

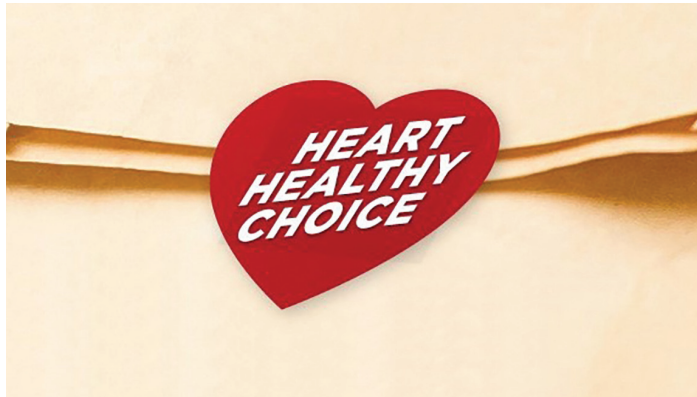

## 24-Hour FasTurn® Special Shapes

SIZE	DIE	GROUP	SHAPE	
1 3/8" x 2 5/8"		540	E	Anniversary
1 3/16" x 3 1/4"		1462	E	Bottle Neck
1 1/8" x 1 1/8"		502	C	Heart
2" x 2"		533	E	Heart
1 7/8" x 2 7/8"		578	J	House
1 1/4" x 3"		545	E	Indented Rect.
2 1/8" x 2 1/8"		1602*	F	Lip Balm
1 7/8" x 3 15/32"		549	I	Marquis
1 1/8" x 2"		553	C	Modified Rect.
1 5/8" x 2"		542	D	Ribbon
1 5/8" x 1 5/8"		526	D	Scallop
2 3/4" x 2 3/4"		507	J	Sheriff Star
2 3/4" x 2 7/8"		534	J	Star
1 1/4" x 2 1/2"		536	D	Triangle
2 1/2" x 3"		1390	I	Vintage Frame

Looking for a unique size or shape? See pages 22-24 for our freeform™ laser cut labels.

\*White film (WB) stock is recommended for Die 1602 - Lip Balm Labels

## 1 Color 24-Hour FasTurn® Special Shapes

Additional ink charges at bottom of price grid.

GROUP	250	500	1,000	2,000	3,000	5,000	10,000	15,000	20,000	25,000
C	\$89.64	\$93.42	\$118.26	\$100.44/m	\$91.80/m	\$70.20/m	\$52.92/m	\$45.36/m	\$41.58/m	\$38.88/m
D	\$93.42	\$97.20	\$121.50	\$107.46/m	\$95.04/m	\$73.44/m	\$56.16/m	\$49.68/m	\$44.28/m	\$41.58/m
E	\$97.20	\$100.44	\$122.04	\$111.78/m	\$99.90/m	\$81.54/m	\$58.86/m	\$50.76/m	\$45.36/m	\$42.66/m
F	\$103.68	\$105.84	\$130.68	\$115.02/m	\$103.68/m	\$84.24/m	\$60.48/m	\$52.38/m	\$46.44/m	\$43.20/m
I	\$115.56	\$122.04	\$150.66	\$135.54/m	\$118.26/m	\$100.44/m	\$77.22/m	\$67.50/m	\$59.94/m	\$55.62/m
J	\$124.20	\$131.76	\$159.84	\$148.50/m	\$127.98/m	\$106.38/m	\$89.10/m	\$75.06/m	\$66.96/m	\$62.64/m
Each Add'l Ink	\$54.00	\$54.00	\$54.00	\$32.50/m	\$22.50/m	\$16.50/m	\$11.50/m	\$9.50/m	\$8.50/m	\$7.50/m
<b>Premium Stocks: Add 25% upcharge to base price for ALL quantities</b>										

(P) Prices effective January 1, 2022.  
Maximum of 3 colors

To ensure 24-Hour production, please submit print-ready artwork by 2pm CT to ship the following day.  
UV Varnish is not included in 1 Color printing; if wanted, add as an additional ink.

## Process Color Pricing • SHIPS IN 24-HOURS!

GROUP	100	250	500	1,000	2,000	3,000	5,000	10,000
C, D, E	\$331.02	\$347.76	\$385.02	\$518.94	\$305.64/m	\$234.36/m	\$176.58/m	\$123.12/m
F	\$371.52	\$391.50	\$488.70	\$593.46	\$378.54/m	\$304.02/m	\$231.12/m	\$142.56/m
I	\$394.20	\$416.34	\$514.08	\$641.52	\$406.08/m	\$325.08/m	\$254.34/m	\$165.78/m
J	\$419.04	\$439.56	\$518.94	\$665.82	\$428.76/m	\$345.60/m	\$267.30/m	\$189.54/m
<b>Premium Stocks: Add 25% upcharge to base price for ALL quantities</b>								

(P) Prices effective January 1, 2022.  
Provide print-ready file (EPS, PDF); sized to chosen label.

To ensure 24-Hour production, please submit print-ready artwork by 2pm CT to ship the following day.  
UV Varnish is applied at no additional cost. Process Color inks are not fade-resistant.



## Quick tips to make your label stand out and make an impact:

- For ink and 24-Hour FasTurn® stock choices, see page 1a.
- Also referred to as “butt cut” because labels are “butted” up next to each other without a gap in between. No waste of space and the label still cleanly peels off the liner.
- To determine your square inches, multiply label width by height.
  - Minimum size square cut labels is 0.25" x 0.625" (One dimension must be a minimum of 0.625")
- Labels are provided on rolls. If individually cut labels are wanted, add a \$35.00 (V) cutting charge per order.
  - Minimum size is 2" x 2"
  - Standard bend & peel, see page 43 for example. Back slit available, if requested.
- Artwork and copy should be 1/8" from all edges. **If bleeds are needed, please call for pricing.**



## 1 Color 24-Hour FasTurn® Square Cut

Additional ink charges at bottom of price grid.

SQUARE INCHES	250	500	1,000	2,000	3,000	5,000	10,000
Up to 1.49	\$136.08	\$169.02	\$208.98	\$139.32/m	\$109.08/m	\$78.84/m	\$52.92/m
1.5 - 2.49	\$142.56	\$173.88	\$217.08	\$148.50/m	\$122.04/m	\$86.94/m	\$56.16/m
2.5 - 3.49	\$150.12	\$183.06	\$230.04	\$169.02/m	\$131.22/m	\$90.18/m	\$60.48/m
3.5 - 4.49	\$156.06	\$189.00	\$235.98	\$172.26/m	\$137.70/m	\$95.04/m	\$61.02/m
4.5 - 5.49	\$158.22	\$192.24	\$241.38	\$178.20/m	\$143.10/m	\$100.44/m	\$65.88/m
5.5 - 6.49	\$162.00	\$197.64	\$243.54	\$180.36/m	\$145.80/m	\$102.06/m	\$66.96/m
6.5 - 7.49	\$165.78	\$201.96	\$252.18	\$186.30/m	\$150.66/m	\$106.92/m	\$72.90/m
7.5 - 8.99	\$173.88	\$211.14	\$264.60	\$196.56/m	\$157.68/m	\$118.26/m	\$84.24/m
9 - 12.99	\$184.14	\$224.10	\$279.72	\$210.06/m	\$169.02/m	\$127.44/m	\$93.96/m
13 - 16.99	\$199.80	\$243.54	\$304.02	\$225.18/m	\$183.60/m	\$144.18/m	\$111.24/m
17 - 21.25	\$214.38	\$261.90	\$325.08	\$251.64/m	\$202.50/m	\$159.30/m	\$125.82/m
21.26 - 24.99	\$238.14	\$291.06	\$354.24	\$305.10/m	\$243.54/m	\$189.00/m	\$146.88/m
25 - 29.99	\$250.56	\$305.64	\$380.16	\$321.30/m	\$257.04/m	\$205.20/m	\$165.78/m
Each Add'l Ink	\$54.00	\$54.00	\$54.00	\$32.50/m	\$22.50/m	\$16.50/m	\$11.50/m

Premium Stocks: Add 25% upcharge to base price for ALL quantities

(P) Prices effective January 1, 2022.  
Maximum of 3 colors

To ensure 24-Hour production, please submit print-ready artwork by 2pm CT to ship the following day.  
UV Varnish is not included in 1 Color printing; if wanted, add as an additional ink.

## Process Color Pricing • SHIPS IN 24-HOURS!

SQUARE INCHES	100	250	500	1,000	2,000	3,000	5,000	10,000
up to 4.99	\$426.06	\$448.74	\$489.24	\$622.08	\$367.20/m	\$274.86/m	\$194.94/m	\$124.74/m
5 - 7.49	\$449.28	\$474.66	\$528.12	\$660.42	\$412.02/m	\$326.16/m	\$243.00/m	\$148.50/m
7.5 - 10.49	\$458.46	\$482.22	\$536.22	\$670.14	\$455.76/m	\$382.32/m	\$261.36/m	\$154.98/m
10.5 - 16.49	\$528.66	\$556.74	\$618.30	\$773.82	\$515.70/m	\$406.08/m	\$315.36/m	\$189.54/m
16.5 - 20.49	\$549.72	\$577.26	\$641.52	\$802.98	\$527.58/m	\$433.62/m	\$318.60/m	\$200.34/m
20.5 - 24	\$691.74	\$729.54	\$811.08	\$1,013.58	\$640.44/m	\$515.70/m	\$396.90/m	\$259.74/m
24.01 - 28	\$753.30	\$793.26	\$881.28	\$1,102.14	\$734.40/m	\$580.50/m	\$434.16/m	\$278.64/m

Premium Stocks: Add 25% upcharge to base price for ALL quantities

(P) Prices effective January 1, 2022.  
Provide print-ready file (EPS, PDF); sized to chosen label.

To ensure 24-Hour production, please submit print-ready artwork by 2pm CT to ship the following day.  
UV Varnish is applied at no additional cost. Process Color inks are not fade-resistant.

# SQUARE CUT FOIL STAMPED AND/OR EMBOSSED

## Quick tips to make your label stand out and make an impact:

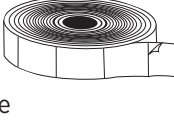
- Also referred to as “butt cut” because labels are “butted” up next to each other without a gap in between. No waste of space and the label still cleanly peels off the liner. 
- Labels are provided on rolls only. Individually cut labels are not available for square cut foil stamped or square cut embossed labels.
- To determine your square inches, multiply label width by height.
  - Minimum size square cut labels is 0.5" x 0.625" (One dimension must be a minimum of 0.625")
- Artwork and copy should be 1/8" from all edges.
- **Bleeds are not available**



## Foil & Embossing Square Inch Guide

	Maximum		Minimum	
	Height	Width	Height	Width
Foil Stamping	5"	8"	.5" (1/4")	.625" (5/8")
Blind Embossing	5"	7"	.5" (1/4")	.625" (5/8")
Foil & Emboss Combination	4"	7"	.5" (1/4")	.625" (5/8")

**Foil Stamp and Emboss Stocks & Imprint Foils** Price includes one standard foil imprint or emboss imprint

**Foil Stamp Standard Stocks**

A White Gloss	G White Matte	BJ Clear Film	D Gold Foil	AI Gold Foil Dull	E Silver Foil	AH Silver Foil Dull	O Black Gloss	P Forest Green Gloss

**Standard Imprint Foils**

Copper	Gold	Silver	Red	Light Blue	Blue	Green	Black	Black Matte	White Matte

**Holographic Foils**

Purple	Teal	Pink	Glitter	Spectrum	Pillars of Light

**Emboss Stocks**

D Gold Foil	AI Gold Foil Dull	E Silver Foil	AH Silver Foil Dull

**Foil Stamp Premium Stocks**

BW Brown Kraft	SW Estate #8	ET Estate #9

**Ink and Foil Combination Imprint available. Call for a quote.**

## Square Cut Foil Stamp and/or Embossed

Additional ink charges at bottom of price grid.

SQUARE INCHES	500	1,000	2,000	3,000	5,000	10,000
Up to 1.49	\$311.04	\$344.52	\$210.60/m	\$161.46/m	\$119.34/m	\$74.52/m
1.5 - 2.49	\$313.74	\$346.68	\$222.48/m	\$167.94/m	\$121.50/m	\$76.68/m
2.5 - 3.49	\$316.44	\$352.62	\$228.42/m	\$172.26/m	\$124.20/m	\$82.62/m
3.5 - 4.49	\$318.60	\$356.94	\$233.82/m	\$175.50/m	\$127.44/m	\$84.78/m
4.5 - 5.49	\$324.54	\$365.04	\$213.84/m	\$181.44/m	\$132.30/m	\$89.10/m
5.5 - 6.49	\$326.16	\$368.28	\$245.70/m	\$191.70/m	\$140.40/m	\$91.80/m
6.5 - 7.49	\$326.70	\$370.98	\$265.14/m	\$200.34/m	\$145.26/m	\$97.74/m
7.5 - 8.99	\$329.94	\$378.54	\$268.92/m	\$207.90/m	\$153.90/m	\$102.60/m
9 - 12.99	\$343.98	\$403.38	\$275.94/m	\$210.60/m	\$154.44/m	\$105.30/m
13 - 16.99	\$361.26	\$432.54	\$288.36/m	\$226.26/m	\$175.50/m	\$134.46/m
17 - 21.25	\$371.52	\$453.06	\$308.88/m	\$250.56/m	\$201.42/m	\$150.66/m
21.26 - 24.99	\$407.16	\$529.20	\$375.30/m	\$319.68/m	\$271.08/m	\$210.60/m
25 - 29.99	\$420.66	\$555.66	\$397.98/m	\$339.12/m	\$289.98/m	\$235.44/m
<b>Additional Foil Upcharge</b>	<b>\$129.00</b>	<b>\$129.00</b>	<b>\$64.50/m</b>	<b>\$42.00/m</b>	<b>\$25.00/m</b>	<b>\$12.50/m</b>
<b>Foil/Emboss Combo Upcharge</b>	<b>\$129.00</b>	<b>\$129.00</b>	<b>\$64.50/m</b>	<b>\$42.00/m</b>	<b>\$25.00/m</b>	<b>\$12.50/m</b>

**Premium Stocks: Add 25% upcharge to base price for ALL quantities**

(P) Prices effective January 1, 2022.

Maximum of 2 Foils or 1 Foil / 1 Emboss Combination.

Production Time: 2-3 Working Days.

# FOIL STAMPED AND/OR EMBOSSED

## Quick tips to make your label stand out and make an impact:

- Use a bold design to make your label and brand stand out.
- Official seals add value and integrity.
- Foil Stamping is the process of imprinting using foil, a die and pressure. This creates a metallic-colored impression that shimmers and shines and captures the eye.
- Embossing involves pressing an image into paper so it is raised above the paper's surface. This raised, or embossed, image subtly stands out on the paperstock, and although ink or foil is not involved, it adds distinction into the design.
- Questions on your artwork? Just ask us! For best quality, we recommend at least a 3 pt thickness on all fonts, borders and fine lines.
- Looking for an ink and cold foil combination? We offer that, too! Call us to discuss.



## Foil Stamped and/or Embossed

SIZE	DIE	GROUP	SHAPE
1 3/8" x 2 5/8"	540	O	Anniversary
1 3/4" x 2 1/4"	531	O	Arch
1 1/4"	510	N	Burst
1 1/2"	547	N	Burst
1 7/8"	523	O	Burst
2 1/4"	524	O	Burst
3/4"	443	N	Circle
1"	402	N	Circle
1 1/8"	439	N	Circle
1 1/4"	435	N	Circle
1 1/2"	424	N	Circle
1 3/4"	407	O	Circle
2"	440	O	Circle
2 1/8"	444	O	Circle
2 1/2"	401	O	Circle
3"	459	O	Circle
3/4" x 1 1/2"	342	N	Oval
1" x 2"	308	N	Oval
1 1/4" x 2 1/2"	357	O	Oval
1 1/2" x 2"	301	O	Oval
1 5/8" x 3"	302	O	Oval
2" x 3"	323	O	Oval
2 7/8" x 3 3/4"	303	O	Oval
1/2" x 1"	102	N	Rectangle
3/4" x 2"	109	N	Rectangle
1" x 1 1/2"	140	N	Rectangle
1" x 2"	155	N	Rectangle
1" x 2 1/2"	110	N	Rectangle
1 1/2" x 2 1/2"	195	O	Rectangle
1 1/2" x 3"	148	O	Rectangle
2" x 3"	145	O	Rectangle
2" x 4"	127	O	Rectangle
2 15/16" x 4"	114	O	Rectangle
1 5/8" x 2"	542	O	Ribbon
1" x 1"	250	N	Square
1 1/2" x 1 1/2"	201	O	Square
2" x 2"	202	O	Square

Looking for a additional metallic effects?  
See page 15 for information on Color-Logic.

## Foil Stamp and/or Embossed

GROUP	500	1,000	2,000	3,000	5,000	10,000
N	\$245.16	\$271.08	\$177.12/m	\$140.94/m	\$109.08/m	\$73.98/m
O	\$252.72	\$285.12	\$200.34/m	\$158.76/m	\$120.42/m	\$86.40/m
Additional Foil Upcharge	\$129.00	\$129.00	\$64.50/m	\$42.00/m	\$25.00/m	\$12.50/m
Foil/Emboss Combo Upcharge	\$129.00	\$129.00	\$64.50/m	\$42.00/m	\$25.00/m	\$12.50/m

Premium Stocks: Add 25% upcharge to base price for ALL quantities

(P) Prices effective January 1, 2022.

Maximum of 2 foils or 1 Foil / 1 Emboss Combination.

Production Time: 2-3 Working Days.

# METALLIC DIGITAL LABELS



## Add shimmer and shine to your design

These labels use the high shine of a metallic stock and semi-translucent inks to transform CMYK colors into a rainbow of vibrant metallic colors. Maximize your design by mixing styles. Use the metallic stock on some areas and contrast it with white ink. The white ink will create an opacity and contrast to the metallic look.

There's almost no limit to the look you can achieve with digitally printed metallic labels!

## Quick tips to make your label stand out and make an impact:

- Create custom color foil backgrounds. For example, yellow will look like metallic gold.
- Utilize opaque white to create an ink and foil combination look.
- Adding a white layer behind small text makes it easier to read so it doesn't blend into the reflective background as well as makes design elements pop.
- Labels are laminated for extra protection and durability.
  - Gloss is standard and provides the high shine look of traditional foil.
  - Matte creates a flat, brushed metal appearance (available if requested).



## Metallic Digital Labels Stocks



KR  
Silver Film  
BOPP

## Metallic Digital Labels

SIZE	DIE	GROUP	SHAPE
1/2" x 1"	102	A	Rectangle
1/2" x 1 1/2"	1312	A	Rectangle
1/2" x 2"	107	A	Rectangle
1/2" x 2 1/2"	1953	B	Rectangle
3/4" x 1"	1280	A	Rectangle
3/4" x 1 1/2"	108	A	Rectangle
3/4" x 1 3/4"	10241	B	Rectangle
3/4" x 2"	109	B	Rectangle
7/8" x 3"	1256	C	Rectangle
1" x 1 1/2"	140	B	Rectangle
1" x 1 3/4"	9586	B	Rectangle
1" x 2"	155	B	Rectangle
1" x 2 1/2"	110	C	Rectangle
1" x 3"	1242	C	Rectangle
1 1/4" x 2"	181	C	Rectangle
1 1/4" x 3 1/2"	1258	F	Rectangle
1 1/2" x 1 3/4"	176	C	Rectangle
1 1/2" x 2"	113	C	Rectangle
1 1/2" x 2 1/4"	1224	D	Rectangle
1 1/2" x 2 1/2"	195	E	Rectangle
1 1/2" x 3"	148	F	Rectangle
1 3/4" x 2 3/4"	142	F	Rectangle
2" x 3"	145	G	Rectangle
2" x 3 1/2"	123	H	Rectangle
2" x 4"	127	H	Rectangle
2 7/8" x 5"	115	K	Rectangle
2 15/16" x 4"	114	J	Rectangle
3" x 4"	1212	J	Rectangle
3" x 5"	1213	K	Rectangle
4" x 5"	1314	L	Rectangle
4" x 6"	185	M	Rectangle
1" x 1"	250	A	Square
1 1/2" x 1 1/2"	201	C	Square
2" x 2"	202	E	Square
2 1/2" x 2 1/2"	204	G	Square
3" x 3"	203	I	Square
4" x 4"	205	K	Square
1 1/4" x 2 1/2"	357	D	Oval
1 5/8" x 3"	302	F	Oval
2" x 3"	323	G	Oval
4" x 6"	358	M	Oval
1"	402	A	Circle
1 1/2"	424	C	Circle
2"	440	E	Circle
2 1/2"	401	G	Circle
3"	459	I	Circle
1 7/8"	523	E	Burst

## Process Color Pricing • SHIPS IN 24-HOURS!

GROUP	100	250	500	1,000	2,000	3,000	5,000	10,000
A, B, C, D, E	\$264.60	\$278.64	\$310.50	\$446.58	\$284.58/m	\$212.22/m	\$169.56/m	\$118.26/m
F, G	\$297.00	\$310.50	\$389.34	\$509.22	\$349.38/m	\$282.96/m	\$222.48/m	\$137.16/m
H, I	\$314.28	\$332.10	\$409.32	\$559.98	\$387.18/m	\$308.34/m	\$244.62/m	\$159.84/m
J, K	\$334.26	\$350.46	\$413.64	\$572.94	\$403.38/m	\$321.30/m	\$257.04/m	\$182.52/m
L	\$361.26	\$376.38	\$453.06	\$618.84	\$419.58/m	\$346.14/m	\$315.90/m	\$237.06/m
M	\$441.18	\$461.70	\$506.52	\$682.56	\$487.08/m	\$385.56/m	\$340.20/m	\$294.30/m

Gloss lamination is standard.

(P) Prices effective January 1, 2022.

Provide print-ready file (EPS, PDF); sized to chosen label.

To ensure 24-Hour production, please submit print-ready artwork by 2:00 pm CT to ship the following day.

Process Color inks are not fade-resistant.



- Create one-of-a-kind labels that cause shelf disruption and promote individual customer experiences.
- Our software crops, enlarges, rotates, scales and moves art file(s) to create randomized outputs for a 100% unique label every time.
- Call for pricing and production time.

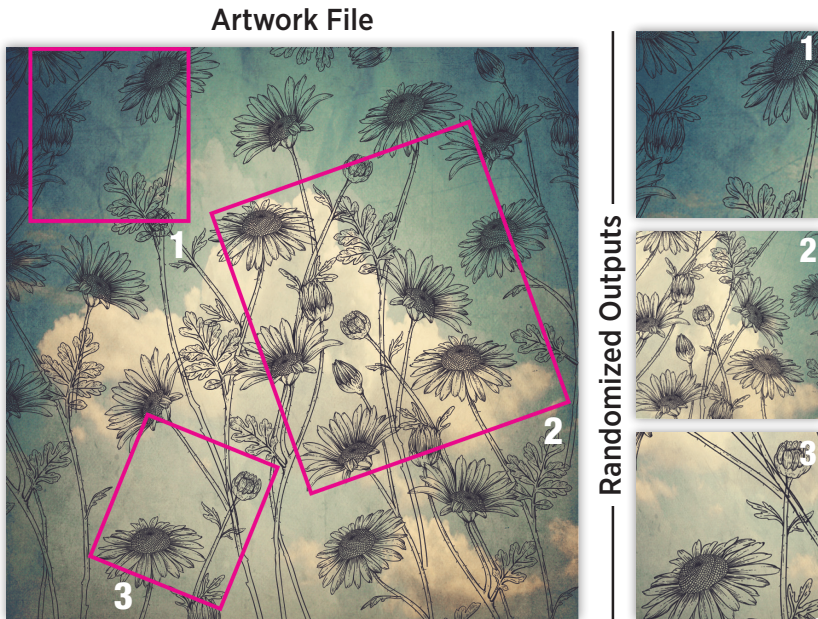

Create eye-catching dimensional effects with Color-Logic Process Metallic Color System™; we use CMYK and white or silver inks to create 250 different metallic colors in a single print run. Produce spectacular effects like watermarks, dimensions, gradients and even security features. Call for pricing and production time.



**Watermark-FX™**  
This effect can be used to make a selected artwork area seem to vanish and reappear, or produce a subtle watermark or security effect.

**Watermark-FX™ PLUS**  
Watermark-FX™ PLUS is a first line of defense against counterfeiting! Add subliminal patterns, wording, even complex guilloches to artwork.

**Dimensional-FX™**  
Dimensional-FX™ makes a selected artwork area appear to change color and dimension, from a lighter to a darker hue as light reflects from the design.

**Gradation-FX™**  
A unique feature of the Color-Logic System is the ability to vignette one metallic color into another, or even vignette metallic hues into process colors.



**Quick tips to make your Label stand out and make an impact:**

- Labels sell beer! A quality, eye-catching label, plays a large role in establishing market share for craft brewers. It can tell a story, the inspiration and the tasting notes of the beer while introducing your brand.
- For ink choices, **see page 1a**. Popular stocks can be found on page 16.
- Clear, White and Silver Film Bopp stocks give a similar appearance to direct print but with lower quantities and greater flexibility.
  - BOPP labels are laminated for extra protection and durability
    - Gloss is standard and provides high shine
    - Matte creates a flat, brushed metal appearance (available if requested).
- Create trendy metallic designs by using Silver Film Bopp stock, Process Color and white ink imprint (**see page 13**) and matte lamination to create shimmer with a satin feel.
- Low minimums are great for seasonal, small batches and special releases.
- Consecutive numbering for limited editions and small batches available, **see page 39**



	Bottle/Can Size	Size of Label	Application	Die	Approximate Gap Between Label Edges
	12 oz Bottle	2 7/8" x 3 3/4"	Oval Front label	303	Varies by back label
	12 oz Bottle	3 1/2" x 4"	Front label	9745	Varies by back label
	12 oz Bottle	3 3/4" x 2 1/2"	Back label	8212	Varies by front label
	12 oz Bottle	3 3/4" x 5 3/4"	3/4 Wrap	1371	1 3/4"
	22 oz (Bomber Bottle)	4 3/4" x 7 1/2"	3/4 Wrap	10522	1 1/2"
	12 oz Can	3 3/4" x 8 3/4"	Full Wrap with Overlap	11220	
	16 oz Can	4 3/4" x 7 1/2"	Full Wrap with Overlap	10522	
	32 oz (Crowler Can)	4 3/4" x 7 1/2"	3/4 Wrap	10522	2 3/4"

**1 Color 24-Hour FasTurn® Beer Labels**

Additional ink charges at bottom of price grid.

SIZE Shape	DIE	250	500	1,000	2,000	3,000	5,000	10,000	15,000	20,000	25,000
1 3/16" x 3 1/4" Bottle Neck	1462	\$97.20	\$100.44	\$122.04	\$111.78/m	\$99.90/m	\$81.54/m	\$58.86/m	\$50.76/m	\$45.36/m	\$42.66/m
2 7/8" x 3 3/4" Oval	303	\$115.56	\$122.04	\$150.66	\$135.54/m	\$118.26/m	\$100.44/m	\$77.22/m	\$67.50/m	\$59.94/m	\$55.62/m
3 1/2" x 4" Rectangle	9745	\$124.20	\$131.76	\$159.84	\$148.50/m	\$127.98/m	\$106.38/m	\$89.10/m	\$75.06/m	\$66.96/m	\$62.64/m
3 3/4" x 2 1/2" Rectangle	8212	\$115.56	\$122.04	\$150.66	\$135.54/m	\$118.26/m	\$100.44/m	\$77.22/m	\$67.50/m	\$59.94/m	\$55.62/m
3 3/4" x 8 3/4" Rectangle	11220	\$283.50	\$298.08	\$365.58	\$302.94/m	\$253.80/m	\$192.78/m	\$146.34/m	\$130.14/m	\$117.72/m	\$110.16/m
3 3/4" x 5 3/4" Rectangle	1371	\$213.84	\$225.18	\$279.18	\$225.72/m	\$179.82/m	\$140.40/m	\$107.46/m	\$95.58/m	\$89.10/m	\$85.32/m
4 3/4" x 7 1/2" Rectangle	10522	\$283.50	\$298.08	\$365.58	\$302.94/m	\$253.80/m	\$192.78/m	\$146.34/m	\$130.14/m	\$117.72/m	\$110.16/m
<b>Each Add'l Ink</b>		<b>\$54.00</b>	<b>\$54.00</b>	<b>\$54.00</b>	<b>\$32.50/m</b>	<b>\$22.50/m</b>	<b>\$16.50/m</b>	<b>\$11.50/m</b>	<b>\$9.50/m</b>	<b>\$8.50/m</b>	<b>\$7.50/m</b>

**Premium Stocks: Add 25% upcharge to base price for ALL quantities**

(P) Prices effective January 1, 2022.  
Maximum of 3 colors

To ensure 24-Hour production, please submit print-ready artwork by 2pm CT to ship the following day.  
UV Varnish is not included in 1 Color printing; if wanted, add as an additional ink.

**Process Color Pricing Beer Labels • Ships in 24-HOURS!**

SIZE Shape	DIE	100	250	500	1,000	2,000	3,000	5,000	10,000
1 3/16" x 3 1/4" Bottle Neck	1462	\$331.02	\$347.76	\$385.02	\$518.94	\$305.64/m	\$234.36/m	\$176.58/m	\$123.12/m
2 7/8" x 3 3/4" Oval	303	\$394.20	\$416.34	\$514.08	\$641.52	\$406.08/m	\$325.08/m	\$254.34/m	\$165.78/m
3 1/2" x 4" Rectangle	9745	\$419.04	\$439.56	\$518.94	\$665.82	\$428.76/m	\$345.60/m	\$267.30/m	\$189.54/m
3 3/4" x 2 1/2" Rectangle	8212	\$394.20	\$416.34	\$514.08	\$641.52	\$406.08/m	\$325.08/m	\$254.34/m	\$165.78/m
3 3/4" x 8 3/4" Rectangle	11220	\$639.36	\$673.92	\$750.60	\$928.80	\$600.48/m	\$483.84/m	\$376.38/m	\$284.58/m
3 3/4" x 5 3/4" Rectangle	1371	\$523.80	\$549.18	\$671.76	\$842.94	\$517.86/m	\$400.14/m	\$305.10/m	\$228.96/m
4 3/4" x 7 1/2" Rectangle	10522	\$639.36	\$673.92	\$750.60	\$928.80	\$600.48/m	\$483.84/m	\$376.38/m	\$284.58/m

**Premium Stocks: Add 25% upcharge to base price for ALL quantities**

(P) Prices effective January 1, 2022.  
Provide print-ready file (EPS, PDF); sized to chosen label.

To ensure 24-Hour production, please submit print-ready artwork by 2pm CT to ship the following day.  
UV Varnish is applied at no additional cost. Process Color inks are not fade-resistant.

**Quick tips to make your Label stand out and make an impact:**

- For ink choices, see page 1a.
- Most beer and wine consumers base their purchasing decisions on the design and look of an enticing label. It tells the brand's story, sets expectations for the quality and consumers will remember the visual aspect of the label on the shelf when they go back to buy more.
- Wine label design trends:
  - Minimal: 1-2 colors, simple shapes or graphics, limited copy; White Matte or Estate #8 stock
  - Modern: Bold images and illustrations with contemporary fonts; Estate #8 stock; Process color.
  - Classic: Illustration of winery, script fonts; Estate #9 stock; Process color.



**Popular Beer & Wine Label Stocks**

<b>Paper</b>		<b>Film / BOPP</b>			<b>Premium</b>		
A White Gloss	G White Matte	WB White Film BOPP	BJ Clear Film BOPP	KR Silver Film BOPP	BW Brown Kraft	SW Estate #8	ET Estate #9
<i>Includes gloss lamination.</i>					<i>Please add a 25% upcharge to all Premium stock orders.</i>		

Our Estate stocks are engineered to withstand water and moisture on submerged bottles without breaking down.  
For additional stock information, see pages 41-42.

**1 Color 24-Hour FasTurn® Wine Bottle Labels**

Additional ink charges at bottom of price grid.

SIZE Shape	DIE	250	500	1,000	2,000	3,000	5,000	10,000	15,000	20,000	25,000
3" x 4" Rectangle	1212	\$119.88	\$126.90	\$153.90	\$143.10/m	\$123.12/m	\$102.06/m	\$85.86/m	\$71.82/m	\$64.80/m	\$60.48/m
3 3/8" x 5" Rectangle	175	\$145.26	\$152.82	\$191.16	\$164.16/m	\$136.62/m	\$112.32/m	\$92.88/m	\$79.38/m	\$71.82/m	\$66.96/m
4" x 5" Rectangle	1314	\$171.72	\$180.36	\$223.56	\$202.50/m	\$173.34/m	\$135.00/m	\$103.68/m	\$94.50/m	\$90.72/m	\$82.08/m
3 1/2" x 3 1/2" Square	254	\$124.20	\$131.76	\$159.84	\$148.50/m	\$127.98/m	\$106.38/m	\$89.10/m	\$75.06/m	\$66.96/m	\$62.64/m
4" x 4" Square	205	\$139.86	\$146.88	\$184.14	\$157.68/m	\$131.76/m	\$108.00/m	\$89.10/m	\$76.68/m	\$69.12/m	\$64.26/m
5" x 5" Square	8554	\$283.50	\$298.08	\$365.58	\$261.90/m	\$211.68/m	\$160.92/m	\$122.04/m	\$116.10/m	\$112.32/m	\$105.30/m
<b>Each Add'l Ink</b>		<b>\$54.00</b>	<b>\$54.00</b>	<b>\$54.00</b>	<b>\$32.50/m</b>	<b>\$22.50/m</b>	<b>\$16.50/m</b>	<b>\$11.50/m</b>	<b>\$9.50/m</b>	<b>\$8.50/m</b>	<b>\$7.50/m</b>

**Premium Stocks: Add 25% upcharge to base price for ALL quantities**

(P) Prices effective January 1, 2022.  
Maximum of 3 colors

To ensure 24-Hour production, please submit print-ready artwork by 2pm CT to ship the following day.  
UV Varnish is not included in 1 Color printing; if wanted, add as an additional ink.

**Process Color Pricing Wine Bottle Labels • Ships in 24-HOURS!**

SIZE Shape	DIE	100	250	500	1,000	2,000	3,000	5,000	10,000
3" x 4" Rectangle	1212	\$334.26	\$350.46	\$413.64	\$572.94	\$403.38/m	\$321.30/m	\$257.04/m	\$182.52/m
3 3/8" x 5" Rectangle	175	\$419.04	\$439.56	\$518.94	\$665.82	\$428.76/m	\$345.60/m	\$267.30/m	\$189.54/m
4" x 5" Rectangle	1314	\$361.26	\$376.38	\$453.06	\$618.84	\$419.58/m	\$346.14/m	\$315.90/m	\$237.06/m
3 1/2" x 3 1/2" Square	254	\$419.04	\$439.56	\$518.94	\$665.82	\$428.76/m	\$345.60/m	\$267.30/m	\$189.54/m
4" x 4" Square	205	\$334.26	\$350.46	\$413.64	\$572.94	\$403.38/m	\$321.30/m	\$257.04/m	\$182.52/m
5" x 5" Square	8554	\$639.36	\$673.92	\$750.60	\$928.80	\$600.48/m	\$483.84/m	\$376.38/m	\$284.58/m

**Premium Stocks: Add 25% upcharge to base price for ALL quantities**

(P) Prices effective January 1, 2022.  
Provide print-ready file (EPS, PDF); sized to chosen label.

To ensure 24-Hour production, please submit print-ready artwork by 2pm CT to ship the following day.  
UV Varnish is applied at no additional cost. Process Color inks are not fade-resistant.

# WATER BOTTLE LABELS



## Quick tips to make your Label stand out and make an impact:

- For ink choices, **see page 1a**. Stock choices below.
- White Film BOPP stock is recommended if you plan to place bottles in ice.
- **Water bottles not included.**
- **Labels are provided on rolls.** If individually cut labels are wanted, add a \$35.00 (V) cutting charge per order.
- Bleeds are available on all four sides.
- UV Varnish is suggested as a moisture barrier and is included on all Process Color orders. On 1 Color orders, price as an additional ink.
- If your label will overlap, make sure to keep important images and words away from the edges of the label.

### Not Sure What Size You Need?

Depending on bottle shape and size, we offer the following suggestions. **PLEASE** measure your purchased water bottles for the closest listed label size.

Bottle Size	Suggested Die	Label Size
16.9 oz.	1394	1 3/4" x 8 1/4"
8 oz.   12 oz.   16.9 oz.	1395	2" x 8"
8 oz.	1396	2 1/2" x 8"
20 oz.	1397	2 3/8" x 9"
20 oz.	1478	3" x 8 3/4"

*Looking for a unique size or shape?  
See pages 22-24 for our freeform™ laser cut labels.*



### Water Bottle Stocks



### 1 Color 24-Hour FasTurn® Water Bottle Labels

Additional ink charges at bottom of price grid.

SIZE	DIE	250	500	1,000	2,000	3,000	5,000	10,000	15,000	20,000	25,000
1 3/4" x 8 1/4"	1394	\$145.26	\$152.82	\$191.16	\$164.16/m	\$136.62/m	\$112.32/m	\$92.88/m	\$79.38/m	\$71.82/m	\$66.96/m
2" x 8"	1395	\$145.26	\$152.82	\$191.16	\$164.16/m	\$136.62/m	\$112.32/m	\$92.88/m	\$79.38/m	\$71.82/m	\$66.96/m
2 1/2" x 8"	1396	\$213.84	\$225.18	\$279.18	\$225.72/m	\$179.82/m	\$140.40/m	\$107.46/m	\$95.58/m	\$89.10/m	\$85.32/m
2 3/8" x 9"	1397	\$213.84	\$225.18	\$279.18	\$225.72/m	\$179.82/m	\$140.40/m	\$107.46/m	\$95.58/m	\$89.10/m	\$85.32/m
3" x 8 3/4"	1478	\$283.50	\$298.08	\$365.58	\$302.94/m	\$253.80/m	\$192.78/m	\$146.34/m	\$130.14/m	\$117.72/m	\$110.16/m
<b>Each Add'l Ink</b>		<b>\$54.00</b>	<b>\$54.00</b>	<b>\$54.00</b>	<b>\$32.50/m</b>	<b>\$22.50/m</b>	<b>\$16.50/m</b>	<b>\$11.50/m</b>	<b>\$9.50/m</b>	<b>\$8.50/m</b>	<b>\$7.50/m</b>

(P) Prices effective January 1, 2022.  
Maximum of 3 colors

To ensure 24-Hour production, please submit print-ready artwork by 2pm CT to ship the following day.  
UV Varnish is not included in 1 Color printing; if wanted, add as an additional ink.

### Process Color Pricing • SHIPS IN 24-HOURS!

SIZE	DIE	100	250	500	1,000	2,000	3,000	5,000	10,000
1 3/4" x 8 1/4"	1394	\$419.04	\$439.56	\$518.94	\$665.82	\$428.76/m	\$345.60/m	\$267.30/m	\$189.54/m
2" x 8"	1395	\$419.04	\$439.56	\$518.94	\$665.82	\$428.76/m	\$345.60/m	\$267.30/m	\$189.54/m
2 1/2" x 8"	1396	\$523.80	\$549.18	\$671.76	\$842.94	\$517.86/m	\$400.14/m	\$305.10/m	\$228.96/m
2 3/8" x 9"	1397	\$523.80	\$549.18	\$671.76	\$842.94	\$517.86/m	\$400.14/m	\$305.10/m	\$228.96/m
3" x 8 3/4"	1478	\$639.36	\$673.92	\$750.60	\$928.80	\$600.48/m	\$483.84/m	\$376.38/m	\$284.58/m

(P) Prices effective January 1, 2022.  
Provide print-ready file (EPS, PDF); sized to chosen label.

To ensure 24-Hour production, please submit print-ready artwork by 2pm CT to ship the following day.  
UV Varnish is applied at no additional cost. Process Color inks are not fade-resistant.





## Quick tips to make your Label stand out and make an impact:

- Let customers know that their health and safety are a top priority. Labels, stickers and seals visually provide a protected experience and environment.
- Provide assurance that vehicles have been cleaned and sanitized after repairs, servicing and test drives; Durable for outdoors; Removable up to 6 months; Vertical perforation for clean break if tampered with
- Provide a sense of security to guests that their room has been cleaned with these temporary seals between the outer door and frame; Vertical perforation for clear break if tampered with
- Secure food containers and bags for carry-out and delivery to assure food safety from kitchen to table

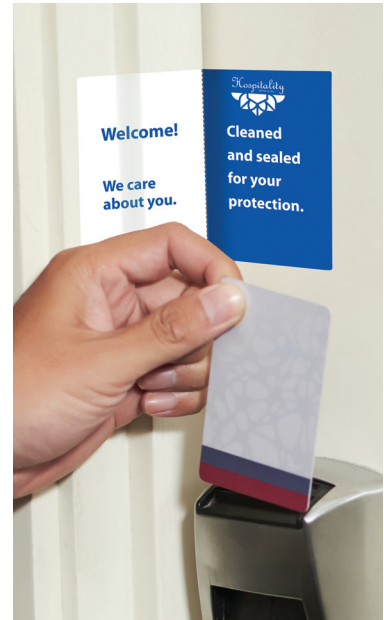

## Safety Seals Stocks



## 1 Color 24-Hour FasTurn® Safety Seals

Additional ink charges at bottom of price grid.

SIZE	DIE	250	500	1,000	2,000	3,000	5,000	10,000	15,000	20,000	25,000
2 ½" x 10" Rectangle	12668	\$283.50	\$298.08	\$365.58	\$302.94/m	\$253.80/m	\$192.78/m	\$146.34/m	\$130.14/m	\$117.72/m	\$110.16/m
2" x 3 ¼" Rectangle	1946	\$109.08	\$114.48	\$137.70	\$120.42/m	\$108.00/m	\$89.10/m	\$65.88/m	\$57.78/m	\$52.92/m	\$49.68/m
3" x 6" Rectangle	9083	\$213.84	\$225.18	\$279.18	\$225.72/m	\$179.82/m	\$140.40/m	\$107.46/m	\$95.58/m	\$89.10/m	\$85.32/m
2 ¾" x 2 ¾" Square	228	\$109.08	\$114.48	\$137.70	\$120.42/m	\$108.00/m	\$89.10/m	\$65.88/m	\$57.78/m	\$52.92/m	\$49.68/m
5" x 5" Square	8554	\$283.50	\$298.08	\$365.58	\$302.94/m	\$253.80/m	\$192.78/m	\$146.34/m	\$130.14/m	\$117.72/m	\$110.16/m
1 ¼" Circle	435	\$82.08	\$86.94	\$106.92	\$93.96/m	\$81.00/m	\$60.48/m	\$43.20/m	\$37.26/m	\$33.48/m	\$31.86/m
2 ½" Circle	401	\$100.44	\$105.30	\$129.60	\$112.32/m	\$102.60/m	\$82.62/m	\$61.02/m	\$52.92/m	\$48.60/m	\$46.44/m
<b>Each Add'l Ink</b>		<b>\$54.00</b>	<b>\$54.00</b>	<b>\$54.00</b>	<b>\$32.50/m</b>	<b>\$22.50/m</b>	<b>\$16.50/m</b>	<b>\$11.50/m</b>	<b>\$9.50/m</b>	<b>\$8.50/m</b>	<b>\$7.50/m</b>

(P) Prices effective January 1, 2022. Maximum of 3 colors

To ensure 24-Hour production, please submit print-ready artwork by 2pm CT to ship the following day. UV Varnish is not included in 1 Color printing; if wanted, add as an additional ink.

## Process Color Pricing • SHIPS IN 24-HOURS!

SIZE	DIE	100	250	500	1,000	2,000	3,000	5,000	10,000
2 ½" x 10" Rectangle	12668	\$639.36	\$673.92	\$750.60	\$928.80	\$600.48/m	\$483.84/m	\$376.38/m	\$284.58/m
2" x 3 ¼" Rectangle	1946	\$394.20	\$416.34	\$514.08	\$641.52	\$406.08/m	\$325.08/m	\$254.34/m	\$165.78/m
3" x 6" Rectangle	9083	\$523.80	\$549.18	\$671.76	\$842.94	\$517.86/m	\$400.14/m	\$305.10/m	\$228.96/m
2 ¾" x 2 ¾" Square	228	\$394.20	\$416.34	\$514.08	\$641.52	\$406.08/m	\$325.08/m	\$254.34/m	\$165.78/m
5" x 5" Square	8554	\$639.36	\$673.92	\$750.60	\$928.80	\$600.48/m	\$483.84/m	\$376.38/m	\$284.58/m
1 ¼" Circle	435	\$331.02	\$347.76	\$385.02	\$518.94	\$305.64/m	\$234.36/m	\$176.58/m	\$123.12/m
2 ½" Circle	401	\$297.00	\$310.50	\$389.34	\$509.22	\$349.38/m	\$282.96/m	\$222.48/m	\$137.16/m

(P) Prices effective January 1, 2022. Provide print-ready file (EPS, PDF); sized to chosen label.

To ensure 24-Hour production, please submit print-ready artwork by 2pm CT to ship the following day. UV Varnish is applied at no additional cost. Process Color inks are not fade-resistant.

# TECH DECAL SHEETS

## Quick tips to make your Label stand out and make an impact:

- Tech Decals keep your message and brand in front of customers 24/7!
- Perfect for laptops, computers, tablets, cell phones, keyboards and more.
- Removable adhesive allows for clean and easy removal even after extended periods of time.
- **FREE** gloss lamination included. *Matte lamination available upon request.*
- Tech Decal Sheets are finished as individuals.
- Custom sizes and shapes available. Call for more information.
- Images not shown to size.

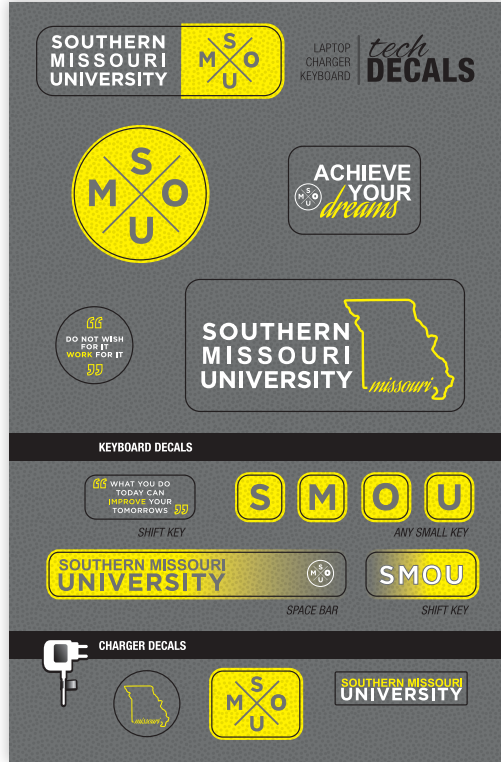

11706 • 5 1/2" x 8 1/2"

### Keyboard Decal Sheet • Size: 3" x 5 1/2"

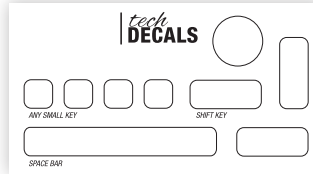

#### Die 11518 • 9 Standard Decals

1/2" x 3 3/8"	Space Bar
1/2" x 1/2"	Keyboard Letters (4)
1/2" x 1 1/4"	Shift Keys (3)
15/16"	Circle

### Tech Decal Sheet • Size: 5 1/2" x 8 1/2"

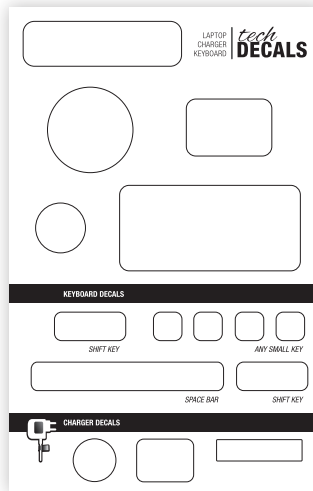

#### Die 11706 • 15 Standard Decals

3/8" x 1 1/2"	Rectangle
1/2" x 1/2"	Keyboard Letters (4)
1/2" x 1 1/4"	Shift Keys (2)
1/2" x 3 3/8"	Space Bar
3/4" x 1"	Rectangle
1" x 1 1/2"	Rectangle
2 3/4" x 3/4"	Rectangle
3 1/4" x 1 1/2"	Rectangle
3/4"	Circle
15/16"	Circle
1 1/2"	Circle



### Tech Decal Stock



## Process Color Tech Keyboard Decals • SHIPS IN 24-HOURS!

SIZE	DIE	100	250	500	1,000	2,000	3,000	5,000	10,000
3" x 5 1/2"	11518	\$247.86	\$292.68	\$372.06	\$529.74	\$422.82/m	\$387.72/m	\$376.38/m	\$359.10/m
5 1/2" x 8 1/2"	11706	\$282.42	\$376.38	\$537.30	\$858.60	\$751.14/m	\$712.80/m	\$700.92/m	\$687.42/m

(P) Prices effective January 1, 2022.

Provide print-ready file (EPS, PDF); sized to chosen label.

To ensure 24-Hour production, please submit print-ready artwork by 2pm CT to ship the following day.



## Quick tips to make your Label stand out and make an impact:

- For ink choices, see page 1a. Stock choices below.
- **FREE** gloss lamination provides protection against moisture, scratching and outside elements. *Matte lamination available upon request.*
- Adding sunscreen lamination protects your labels and may extend the fade resistance of some inks, depending on environment and usage..
- Bumper Stickers are finished as individual stickers.
- Rectangle Bumper Stickers have a convenient bend and peel tab. **See page 43 for an example.**
- 4" x 6" ovals and 5" circles are die cut for easy removal from liner.



## Bumper Sticker Stocks



J  
White  
Polyolefin



JR  
Removable  
White Polyolefin

## 1 Color 24-Hour FasTurn® Bumper Stickers

Additional ink charges at bottom of price grid.

SIZE Shape	DIE	100	250	500	1,000	2,000	3,000	5,000	10,000
2 3/4" x 4 7/8" Sq. Corner Rectangle	1264	\$240.84	\$271.62	\$328.32	\$447.66	\$305.10/m	\$255.42/m	\$202.50/m	\$153.90/m
3" x 11 3/8" Sq. Corner Rectangle	1226	\$333.72	\$365.04	\$489.78	\$655.56	\$494.10/m	\$441.18/m	\$396.36/m	\$362.34/m
3 3/4" x 7 7/8" Sq. Corner Rectangle	1227	\$294.84	\$304.02	\$381.24	\$485.46	\$348.84/m	\$291.60/m	\$235.98/m	\$193.32/m
3 3/4" x 14 7/8" Sq. Corner Rectangle	1228	\$333.72	\$365.04	\$489.78	\$655.56	\$494.10/m	\$441.18/m	\$396.36/m	\$362.34/m
4" x 6" Sq. Corner Rectangle	1313	\$294.84	\$304.02	\$381.24	\$485.46	\$348.84/m	\$291.60/m	\$235.98/m	\$193.32/m
4" x 6" Oval	358	\$294.84	\$304.02	\$381.24	\$485.46	\$348.84/m	\$291.60/m	\$235.98/m	\$193.32/m
5" Circle	468	\$294.84	\$304.02	\$381.24	\$485.46	\$348.84/m	\$291.60/m	\$235.98/m	\$193.32/m
<b>Each Add'l Ink</b>		<b>\$54.00</b>	<b>\$54.00</b>	<b>\$54.00</b>	<b>\$54.00</b>	<b>\$32.50/m</b>	<b>\$22.50/m</b>	<b>\$16.50/m</b>	<b>\$11.50/m</b>
<b>Sunscreen Lamination</b>		<b>\$182.00</b>	<b>\$182.00</b>	<b>\$182.00</b>	<b>\$182.00</b>	<b>\$107.00/m</b>	<b>\$85.50/m</b>	<b>\$80.00/m</b>	<b>\$54.00/m</b>
<b>Removable Stock Upgrade</b>		<b>\$41.00</b>	<b>\$41.00</b>	<b>\$41.00</b>	<b>\$72.00</b>	<b>\$66.00/m</b>	<b>\$62.00/m</b>	<b>\$51.50/m</b>	<b>\$41.00/m</b>

(P) Prices effective January 1, 2022.  
Maximum of 3 colors

To ensure 24-Hour production, please submit print-ready artwork by 2pm CT to ship the following day.  
Gloss Lamination is applied at no additional cost.

## Process Color Pricing • SHIPS IN 24-HOURS!

SIZE Shape	DIE	100	250	500	1,000	2,000	3,000	5,000	10,000
2 3/4" x 4 7/8" Sq. Corner Rectangle	1264	\$586.44	\$617.22	\$700.92	\$876.96	\$585.90/m	\$486.54/m	\$394.20/m	\$287.28/m
3" x 11 3/8" Sq. Corner Rectangle	1226	\$787.32	\$821.34	\$954.18	\$1,259.82	\$877.50/m	\$710.10/m	\$565.92/m	\$335.34/m
3 3/4" x 7 7/8" Sq. Corner Rectangle	1227	\$639.36	\$673.38	\$733.86	\$915.84	\$615.06/m	\$511.92/m	\$409.86/m	\$315.90/m
3 3/4" x 14 7/8" Sq. Corner Rectangle	1228	\$787.32	\$821.34	\$954.18	\$1,259.82	\$877.50/m	\$710.10/m	\$565.92/m	\$335.34/m
4" x 6" Sq. Corner Rectangle	1313	\$639.36	\$673.38	\$733.86	\$915.84	\$615.06/m	\$511.92/m	\$409.86/m	\$315.90/m
4" x 6" Oval	358	\$639.36	\$673.38	\$733.86	\$915.84	\$615.06/m	\$511.92/m	\$409.86/m	\$315.90/m
5" Circle	468	\$639.36	\$673.38	\$733.86	\$915.84	\$615.06/m	\$511.92/m	\$409.86/m	\$315.90/m
<b>Sunscreen Lamination</b>		<b>\$182.00</b>	<b>\$182.00</b>	<b>\$182.00</b>	<b>\$182.00</b>	<b>\$107.00/m</b>	<b>\$85.50/m</b>	<b>\$80.00/m</b>	<b>\$54.00/m</b>
<b>Removable Stock Upgrade</b>		<b>\$41.00</b>	<b>\$41.00</b>	<b>\$41.00</b>	<b>\$72.00</b>	<b>\$66.00/m</b>	<b>\$62.00/m</b>	<b>\$51.50/m</b>	<b>\$41.00/m</b>

(P) Prices effective January 1, 2022.  
Provide print-ready file (EPS, PDF); sized to chosen label.

To ensure 24-Hour production, please submit print-ready artwork by 2pm CT to ship the following day.  
Gloss Lamination is applied at no additional cost. Process Color inks are not fade resistant.

# SPECIALTY APPLICATION LABELS

## Coupons & Clean Release Labels



Designed with a dry release adhesive that allows the end user to remove the top layer of the coupon. The coupon is not sticky once removed and can be printed on one or both sides.

## Direct Thermal & Thermal Transfer Labels



Thermal Transfer labels use wax or resin ribbons to print. Direct Thermal labels use heat sensitive paper that turns the print black. These blank or printed labels are offered with a variety of adhesives and varnishes.

## Double Sided Labels



Double-sided labels are printed on both the front and back (adhesive side), allowing the label to be viewed from either side of a clear surface side like windows, doors, and store display coolers.

## RTS - Rough & Textured Surface Stock



This durable yet flexible white vinyl stock has a permanent acrylic adhesive made for powder coated painted surfaces, concrete, lumber/wood and fiberglass. Ideal stock for outdoor equipment, recreational vehicles, sporting equipment, power tools, appliances and more!

## Self-Laminating Labels

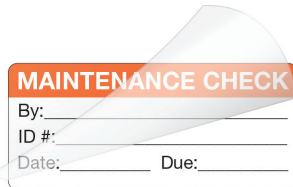

These durable labels begin as a standard label but have a lamination that is partially applied. The self lamination feature protects your writing and helps keep the label surface protected in harsh environments.

## Washable Stock



A durable way to label and brand items that need washing! White Premium Vinyl labels with a durable lamination that are dishwasher and laundry safe.

## Tamper Evident Labels



These security stocks break apart or leave a "VOID" message on the surface when they have been removed. Available in Silver Void or White Destructible stocks.

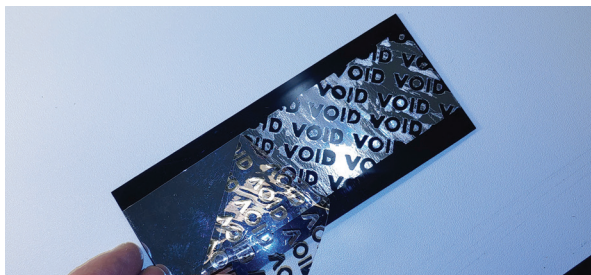

## Tire Adhesive Labels



These labels have a very aggressive, high tack, permanent adhesive that is designed to stick to rubber and other difficult surfaces.

## Additional Options Available

- Cold foil and ink combination (flexographic)
- Piggy Back
- Scratch Off
- Shrink Sleeves

FOR MORE INFORMATION AND PRICING ON THESE OR ANY OTHER LABELS - CONTACT US!



**Quick tips to make your Label stand out and make an impact:**

- Sticker sheets can be an essential contribution to a fun yet practical promotional item for your brand.
- Custom label and sticker sheets are the answer when you need a label with multiple cuts. Or when you have a product that needs multiple labels but are different sizes and shapes. Laser cutting to the rescue!
- No costly custom dies are needed as the cutting is done with a laser beam! Yup, that's what we use for our freeform™ labels on **pages 23 & 24**, too!
- Pricing is determined by the size of the sheet (total square inches) - not the number of shapes.
- **Please provide a layered art file with a cut path for each sticker shape on your sheet as well the overall size of your label sheet.**
  - We can help create cut paths and make sure your stickers look their best.  
**Art charges start at \$25.00 (Z) and may increase production time.**
  - Ask an associate if you need assistance on how to create your cut path/die line.
- Production time on most sticker sheets is 24-Hour if a layered art file with cut path is provided to size.

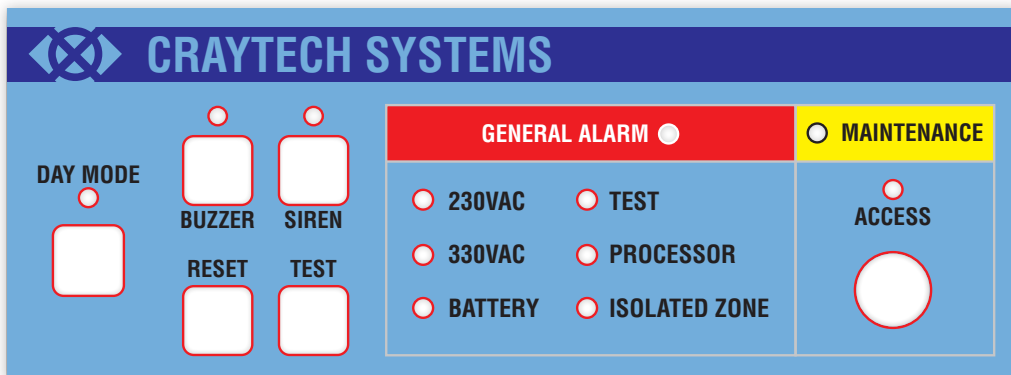

See freeform™ pages 23 & 24 for our stock offering and pricing.

Looking for a special stock or larger size? Contact us and we'd be glad to find the best solution for your need!

**Quick tips to make your Label stand out and make an impact:**

- Laser cutting technology expands your creative options with unique and impressive shapes to make your label the shape it needs to be.
- Minimum label size is 1/2" x 1/2". Call for pricing on labels larger than 24 square inches.
- Make sure to provide a layered art file with a die line/cut path with your order to avoid set-up fees.
  - Art charge for creating die lines starts at \$25.00 (Z) and may increase production time.
- For ink choices, see page 1a. Stock choices below.
- Labels are provided on rolls. If individually cut labels are wanted, add a \$35.00 (V) cutting charge per order.
  - Minimum size is 2" x 2".



**freeform™ Stocks**

<b>Gloss</b>					<b>Matte</b>						
A White Gloss	Q White Gloss Blackout	AS White Gloss Removable	BC Ivory Gloss	B Yellow Gloss	G White Matte	R White Matte Blackout	BF White Matte Removable	BH Ivory Matte	AM Yellow Matte	H White EDP	
<b>Fluorescent</b>					<b>Recycled</b>		<b>Film / BOPP</b>		<b>Premium</b>		
I Green Fluorescent	AE Orange Fluorescent	AF Pink Fluorescent	AG Chartreuse Fluorescent	C Red Fluorescent	TR 30% Recycled Semi-Gloss	WB White Film BOPP	KR Silver Film BOPP	BW Brown Kraft	SW Estate #8	ET Estate #9	

**1 Color 24-Hour freeform™**

Additional ink charges at bottom of price grid.

SQUARE INCHES	100	250	500	1,000	2,000	3,000	5,000	10,000
Up to 4.99	\$195.48	\$199.26	\$200.34	\$244.62	\$147.96/m	\$108.54/m	\$76.14/m	\$50.76/m
5 to 7.49	\$203.58	\$206.28	\$207.90	\$255.42	\$199.80/m	\$160.38/m	\$122.04/m	\$92.88/m
7.5 to 10.49	\$226.80	\$227.88	\$231.12	\$281.88	\$212.22/m	\$174.42/m	\$143.10/m	\$115.02/m
10.5 to 16.49	\$240.30	\$256.50	\$260.28	\$312.66	\$248.94/m	\$211.14/m	\$171.72/m	\$149.58/m
16.5 to 20.49	\$243.00	\$271.62	\$274.32	\$341.28	\$269.46/m	\$221.40/m	\$180.90/m	\$154.44/m
20.5 to 24	\$246.78	\$278.64	\$308.88	\$378.54	\$321.84/m	\$251.10/m	\$216.54/m	\$180.36/m
<b>Each Add'l Ink</b>	<b>\$54.00</b>	<b>\$54.00</b>	<b>\$54.00</b>	<b>\$54.00</b>	<b>\$32.50/m</b>	<b>\$22.50/m</b>	<b>\$16.50/m</b>	<b>\$11.50/m</b>
<b>Premium Stocks: Add 25% upcharge to base price for ALL quantities</b>								

(P) Prices effective January 1, 2022. Maximum of 3 colors

To ensure 24-Hour production, please submit print-ready artwork by 2pm CT to ship the following day. UV Varnish is not included in 1 Color printing; if wanted, add as an additional ink.

**Process Color Pricing • SHIPS IN 24-HOURS!**

SQUARE INCHES	100	250	500	1,000	2,000	3,000	5,000	10,000
Up to 4.99	\$329.94	\$360.18	\$426.60	\$551.88	\$286.20/m	\$239.76/m	\$182.52/m	\$122.04/m
5 to 7.49	\$382.32	\$424.44	\$501.66	\$640.98	\$410.40/m	\$327.24/m	\$220.86/m	\$128.52/m
7.5 to 10.49	\$406.08	\$454.68	\$532.44	\$679.86	\$451.98/m	\$344.52/m	\$240.30/m	\$139.32/m
10.5 to 16.49	\$500.58	\$552.42	\$643.68	\$797.04	\$496.80/m	\$373.68/m	\$274.32/m	\$165.24/m
16.5 to 20.49	\$522.72	\$579.42	\$671.22	\$861.84	\$536.22/m	\$403.92/m	\$294.84/m	\$199.26/m
20.5 to 24	\$623.16	\$648.00	\$785.16	\$1,075.68	\$632.34/m	\$488.16/m	\$373.14/m	\$285.12/m
<b>Premium Stocks: Add 25% upcharge to base price for ALL quantities</b>								

(P) Prices effective January 1, 2022. Provide print-ready file (EPS, PDF); sized to chosen label.

To ensure 24-Hour production, please submit print-ready artwork by 2pm CT to ship the following day. UV Varnish is applied at no additional cost. Process Color inks are not fade-resistant.

**Quick tips to make your Label stand out and make an impact:**

- Same great features as **page 23**.
  - For ink choices, **see page 1a**. Stock choices below.
  - White back-up is suggested on Clear Polyester, **see page 44**.
  - **FREE** gloss lamination provides protection against moisture, scratching and outside elements.
    - Matte lamination is available, if requested.
    - Recommended if you plan to write on the label.*
  - Adding sunscreen lamination protects your labels and may extend the fade resistance of some inks, depending on environment and usage.
- See price grid below for additional charge.*



Height 2.153"  
Width 2"  
2.153" x 2"  
4.3 Square Inch Label

**freeform™ Outdoor Stocks**



Y  
Clear  
Polyester



J  
White  
Polyolefin



S  
Silver Polyester  
Brushed



X  
Silver  
Polyester



V  
Yellow  
Polyolefin



Z  
Gold Polyester  
Brushed



U  
Gold  
Polyester



JR  
Removable  
White Polyolefin

**Standard Outdoor**

**Removable**

**1 Color 24-Hour freeform™ Outdoor**

Additional ink charges at bottom of price grid.

SQUARE INCHES	100	250	500	1,000	2,000	3,000	5,000	10,000
Up to 4.99	\$229.50	\$233.28	\$294.30	\$333.72	\$238.14/m	\$195.48/m	\$147.96/m	\$103.68/m
5 to 7.49	\$242.46	\$247.86	\$313.74	\$393.12	\$277.02/m	\$225.18/m	\$183.06/m	\$150.66/m
7.5 to 10.49	\$272.16	\$273.24	\$342.90	\$402.84	\$296.46/m	\$245.16/m	\$202.50/m	\$170.64/m
10.5 to 16.49	\$309.96	\$313.74	\$370.98	\$429.84	\$319.68/m	\$266.22/m	\$244.62/m	\$211.14/m
16.5 to 20.49	\$312.66	\$334.26	\$393.12	\$475.20	\$327.24/m	\$282.42/m	\$263.52/m	\$245.16/m
20.5 to 24	\$325.62	\$357.48	\$411.48	\$519.48	\$405.00/m	\$354.24/m	\$311.04/m	\$278.64/m
Each Add'l Ink	\$54.00	\$54.00	\$54.00	\$54.00	\$32.50/m	\$22.50/m	\$16.50/m	\$11.50/m
Sunscreen Lamination	\$182.00	\$182.00	\$182.00	\$182.00	\$107.00/m	\$85.50/m	\$80.00/m	\$54.00/m
Removable Stock Upgrade	\$41.00	\$41.00	\$41.00	\$72.00	\$66.00/m	\$62.00/m	\$51.50/m	\$41.00/m

(P) Prices effective January 1, 2022.  
Maximum of 3 colors

To ensure 24-Hour production, please submit print-ready artwork by 2pm CT to ship the following day.  
Gloss Lamination is applied at no additional cost.

**Process Color Pricing • SHIPS IN 24-HOURS!**

SQUARE INCHES	100	250	500	1,000	2,000	3,000	5,000	10,000
Up to 4.99	\$413.10	\$529.74	\$564.84	\$653.94	\$432.00/m	\$344.52/m	\$252.18/m	\$164.16/m
5 to 7.49	\$433.62	\$538.92	\$598.32	\$698.22	\$449.82/m	\$361.80/m	\$310.50/m	\$195.48/m
7.5 to 10.49	\$464.94	\$565.38	\$625.32	\$729.54	\$477.36/m	\$393.12/m	\$318.60/m	\$228.42/m
10.5 to 16.49	\$501.12	\$605.88	\$645.84	\$784.08	\$527.04/m	\$429.84/m	\$331.02/m	\$279.72/m
16.5 to 20.49	\$546.48	\$664.74	\$727.92	\$901.26	\$619.38/m	\$486.00/m	\$363.96/m	\$291.06/m
20.5 to 24	\$632.88	\$682.56	\$746.28	\$997.38	\$666.36/m	\$528.66/m	\$404.46/m	\$330.48/m
Sunscreen Lamination	\$182.00	\$182.00	\$182.00	\$182.00	\$107.00/m	\$85.50/m	\$80.00/m	\$54.00/m
Removable Stock Upgrade	\$41.00	\$41.00	\$41.00	\$72.00	\$66.00/m	\$62.00/m	\$51.50/m	\$41.00/m

(P) Prices effective January 1, 2022.  
Provide print-ready file (EPS, PDF); sized to chosen label.

To ensure 24-Hour production, please submit print-ready artwork by 2pm CT to ship the following day.  
Gloss Lamination is applied at no additional cost. Process Color inks are not fade-resistant.

# REPOSITIONABLE WINDOW DECALS

## Quick tips to make your Label stand out and make an impact:

- Window decals for indoor and outdoor use.
- For ink choices, **see page 1a**. Stock choices below.
- Our window decals have a special adhesive that allows you to remove and reposition multiple times on a clean surface and leaves no residue.
- Please indicate if decal will be read from the inside or outside of a window.
  - Reversed copy available only on Clear Window Lite stock (WC).
  - Lamination is not available on reversed copy decals.
- **FREE** gloss lamination provides protection against moisture and scratching.
  - Matte lamination is available, if requested. *Recommended if you plan to write on the decal.*
- Adding sunscreen lamination protects your labels and may extend the fade resistance of some inks, depending on environment and usage.
- **FREE** white ink back-up applied unless indicated otherwise. See example below.
- Individually cut decals available upon request. *Square corner rectangles come standard as individuals.*
  - Add a \$35.00 (V) cutting charge per order.
  - Minimum size is 2" x 2".

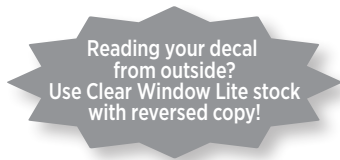

### Repositionable Window Decal Stocks



\* For Clear Window Lite Stock, please indicate on your order if copy will be read from the inside or outside of the window.

NO WHITE BACK-UP OR FLOOD

WHITE BACK-UP

WHITE FLOOD COAT



WITHOUT WHITE BACK-UP

WITH WHITE BACK-UP

### 1 Color 24-Hour Repositionable Window Decals

Additional ink charges at bottom of price grid.

SIZE Shape	DIE	250	500	1,000	2,000	3,000	5,000	10,000
1 1/2" x 2" Rectangle	113	\$359.64	\$400.68	\$470.34	\$297.54/m	\$216.54/m	\$146.88/m	\$93.42/m
1 1/2" x 2 1/2" Rectangle	195	\$359.64	\$400.68	\$470.34	\$297.54/m	\$216.54/m	\$146.88/m	\$93.42/m
2" x 3" Rectangle	145	\$373.14	\$415.26	\$489.78	\$308.34/m	\$231.66/m	\$168.48/m	\$118.80/m
2 1/4" x 4" Rectangle	166	\$388.80	\$432.00	\$508.14	\$349.38/m	\$265.14/m	\$197.10/m	\$142.02/m
3" x 4" Rectangle	1212	\$418.50	\$466.02	\$547.56	\$370.44/m	\$307.80/m	\$255.42/m	\$205.74/m
3 1/4" x 5" Rectangle	1201	\$418.50	\$466.02	\$547.56	\$370.44/m	\$307.80/m	\$255.42/m	\$205.74/m
4" x 5" Rectangle	1314	\$491.94	\$546.48	\$660.96	\$466.02/m	\$397.98/m	\$332.10/m	\$281.34/m
4" x 6" Rectangle	185	\$491.94	\$546.48	\$660.96	\$466.02/m	\$397.98/m	\$332.10/m	\$281.34/m
5" x 7" Rectangle	1233	\$520.56	\$578.34	\$758.70	\$529.20/m	\$447.66/m	\$380.16/m	\$328.86/m
2" x 2" Square	202	\$359.64	\$400.68	\$470.34	\$297.54/m	\$216.54/m	\$146.88/m	\$93.42/m
3" x 3" Square	203	\$388.80	\$432.00	\$508.14	\$349.38/m	\$265.14/m	\$197.10/m	\$142.02/m
4" x 4" Square	205	\$418.50	\$466.02	\$547.56	\$370.44/m	\$307.80/m	\$255.42/m	\$205.74/m
3" x 11 1/2" Sq. Corner Rect.	1226	\$520.56	\$578.34	\$758.70	\$529.20/m	\$447.66/m	\$380.16/m	\$328.86/m
3 3/4" x 7 1/2" Sq. Corner Rect.	1227	\$491.94	\$546.48	\$660.96	\$466.02/m	\$397.98/m	\$332.10/m	\$281.34/m
2" x 3" Oval	323	\$373.14	\$415.26	\$489.78	\$308.34/m	\$231.66/m	\$168.48/m	\$118.80/m
4" x 6" Oval	358	\$491.94	\$546.48	\$660.96	\$466.02/m	\$397.98/m	\$332.10/m	\$281.34/m
3" Circle	459	\$388.80	\$432.00	\$508.14	\$349.38/m	\$265.14/m	\$197.10/m	\$142.02/m
4" Circle	432	\$418.50	\$466.02	\$547.56	\$370.44/m	\$307.80/m	\$255.42/m	\$205.74/m
5" Circle	468	\$491.94	\$546.48	\$660.96	\$466.02/m	\$397.98/m	\$332.10/m	\$281.34/m
6" Circle	465	\$520.56	\$578.34	\$758.70	\$529.20/m	\$447.66/m	\$380.16/m	\$328.86/m
<b>Each Add'l Ink</b>		<b>\$54.00</b>	<b>\$54.00</b>	<b>\$54.00</b>	<b>\$32.50/m</b>	<b>\$22.50/m</b>	<b>\$16.50/m</b>	<b>\$11.50/m</b>
<b>Sunscreen Lamination</b>		<b>\$182.00</b>	<b>\$182.00</b>	<b>\$182.00</b>	<b>\$107.00/m</b>	<b>\$85.50/m</b>	<b>\$80.00/m</b>	<b>\$54.00/m</b>

(P) Prices effective January 1, 2022. Maximum of 3 colors

Production Time: 1 or 2 Color - 24-Hour; 3 Color - 2 Working Days. Gloss lamination is applied at no additional cost. To ensure 24-Hour production, please submit print-ready artwork by 2pm CT to ship the following day.

# REPOSITIONABLE WINDOW DECALS



## Process Color Pricing • SHIPS IN 24-HOURS!

SIZE Shape	DIE	250	500	1,000	2,000	3,000	5,000	10,000
1 1/2" x 2" Rectangle	113	\$388.80	\$432.00	\$582.12	\$347.22/m	\$267.30/m	\$196.02/m	\$125.82/m
1 1/2" x 2 1/2" Rectangle	195	\$388.80	\$432.00	\$582.12	\$347.22/m	\$267.30/m	\$196.02/m	\$125.82/m
2" x 3" Rectangle	145	\$492.48	\$548.64	\$665.28	\$424.98/m	\$344.52/m	\$276.48/m	\$162.54/m
2 1/4" x 4" Rectangle	166	\$517.32	\$573.48	\$719.28	\$469.26/m	\$384.48/m	\$312.12/m	\$190.62/m
3" x 4" Rectangle	1212	\$524.34	\$583.20	\$746.28	\$483.30/m	\$393.66/m	\$318.60/m	\$214.38/m
3 1/4" x 5" Rectangle	1201	\$524.34	\$583.20	\$746.28	\$483.30/m	\$393.66/m	\$318.60/m	\$214.38/m
4" x 5" Rectangle	1314	\$739.80	\$820.80	\$1,025.46	\$684.18/m	\$570.24/m	\$445.50/m	\$349.92/m
4" x 6" Rectangle	185	\$739.80	\$820.80	\$1,025.46	\$684.18/m	\$570.24/m	\$445.50/m	\$349.92/m
5" x 7" Rectangle	1233	\$822.42	\$914.76	\$1,176.66	\$887.76/m	\$772.74/m	\$678.78/m	\$602.10/m
2" x 2" Square	202	\$388.80	\$432.00	\$582.12	\$347.22/m	\$267.30/m	\$196.02/m	\$125.82/m
3" x 3" Square	203	\$517.32	\$573.48	\$719.28	\$469.26/m	\$384.48/m	\$312.12/m	\$190.62/m
4" x 4" Square	205	\$524.34	\$583.20	\$746.28	\$483.30/m	\$393.66/m	\$318.60/m	\$214.38/m
3" x 11 1/2" Sq. Corner Rect.	1226	\$822.42	\$914.76	\$1,176.66	\$887.76/m	\$772.74/m	\$678.78/m	\$602.10/m
3 3/4" x 7 1/2" Sq. Corner Rect.	1227	\$739.80	\$820.80	\$1,025.46	\$684.18/m	\$570.24/m	\$445.50/m	\$349.92/m
2" x 3" Oval	323	\$492.48	\$548.64	\$665.28	\$424.98/m	\$344.52/m	\$276.48/m	\$162.54/m
4" x 6" Oval	358	\$739.80	\$820.80	\$1,025.46	\$684.18/m	\$570.24/m	\$445.50/m	\$349.92/m
3" Circle	459	\$517.32	\$573.48	\$719.28	\$469.26/m	\$384.48/m	\$312.12/m	\$190.62/m
4" Circle	432	\$524.34	\$583.20	\$746.28	\$483.30/m	\$393.66/m	\$318.60/m	\$214.38/m
5" Circle	468	\$739.80	\$820.80	\$1,025.46	\$684.18/m	\$570.24/m	\$445.50/m	\$349.92/m
6" Circle	465	\$822.42	\$914.76	\$1,176.66	\$887.76/m	\$772.74/m	\$678.78/m	\$602.10/m
<b>Sunscreen Lamination</b>		<b>\$182.00</b>	<b>\$182.00</b>	<b>\$182.00</b>	<b>\$107.00/m</b>	<b>\$85.50/m</b>	<b>\$80.00/m</b>	<b>\$54.00/m</b>

(P) Prices effective January 1, 2022.

Provide print-ready file (EPS, PDF); sized to chosen label.

To ensure 24-Hour production, please submit print-ready artwork by 2pm CT to ship the following day.

Gloss lamination is applied at no additional cost. Process color inks are not fade resistant.

# OUTDOOR RECTANGLES & SQUARES



**Quick tips to make your Label stand out and make an impact:**

- For ink choices, see page 1a. Stock choices, see page 28.
- White back-up is suggested on clear stocks, see page 44.
- Labels are provided on rolls. If individually cut labels are wanted, add a \$35.00 (V) cutting charge per order.
  - Minimum size is 2" x 2".
- **FREE** gloss lamination provides protection against moisture, scratching and outside elements.
  - Matte lamination is available, if requested.
  - Recommended if you plan to write on the label.
- Adding sunscreen lamination protects your labels and may extend the fade resistance of some inks, depending on environment and usage. See price grid on page 28 for additional charge.
- Consecutive numbering available, see page 39.



## Outdoor Rectangles

SIZE	DIE	GROUP
3/4" x 2"	109	P
15/16" x 3"	126	Q
1" x 2"	155	P
1" x 2 1/2"	110	Q
1" x 3"	1242	Q
1" x 4"	1214	Q
1 1/4" x 2"	181	Q
1 1/4" x 3 1/2"	1258	R
1 1/2" x 2 1/2"	195	Q
1 1/2" x 3"	148	Q
1 1/2" x 3 1/2"	143	R
1 3/4" x 3"	121	R
2" x 2 1/2"	151	R
2" x 3"	145	R
2" x 3 1/2"	123	S
2" x 4"	127	S
2" x 6"	1243	U
2 1/2" x 4"	1204	T
2 7/8" x 5"	115	V
2 15/16" x 4"	114	U
3" x 4"	1212	U
3" x 5"	1213	V
4" x 6"	185	W
5" x 7"	1233	X



## Outdoor Squares

SIZE	DIE	GROUP
1" x 1"	250	P
2" x 2"	202	Q
2 1/2" x 2 1/2"	204	S
3" x 3"	203	T
4" x 4"	205	V
5" x 5"	8554	W

Looking for a unique size or shape?  
See pages 22-24 for our  
freemove™ laser cut labels.



# OUTDOOR RECTANGLES & SQUARES



## Outdoor Stocks



Y  
Clear Polyester



J  
White Polyolefin



S  
Silver Polyester Brushed



X  
Silver Polyester



V  
Yellow Polyolefin



Z  
Gold Polyester Brushed



U  
Gold Polyester

### Standard

### Removable



JR  
Removable White Polyolefin

Stock for rough & textured surfaces available. Call for a quote.

## 1 Color 24-Hour Outdoor Rectangles & Squares

Additional ink charges at bottom of price grid.

GROUP	250	500	1,000	2,000	3,000	5,000	10,000
P	\$192.24	\$262.98	\$355.86	\$213.84/m	\$163.08/m	\$118.26/m	\$83.70/m
Q	\$219.24	\$285.12	\$383.94	\$241.38/m	\$190.62/m	\$147.42/m	\$112.86/m
R	\$237.06	\$300.24	\$406.08	\$259.74/m	\$207.36/m	\$159.84/m	\$123.66/m
S	\$244.62	\$319.14	\$430.38	\$281.34/m	\$235.44/m	\$194.40/m	\$149.04/m
T	\$250.56	\$325.08	\$443.88	\$293.22/m	\$252.72/m	\$201.42/m	\$153.36/m
U	\$271.62	\$328.32	\$447.66	\$305.10/m	\$255.42/m	\$202.50/m	\$153.90/m
V	\$277.56	\$334.80	\$451.98	\$308.34/m	\$258.12/m	\$204.12/m	\$155.52/m
W	\$304.02	\$381.24	\$485.46	\$348.84/m	\$291.60/m	\$235.98/m	\$193.32/m
X	\$365.04	\$489.78	\$655.56	\$494.10/m	\$441.18/m	\$396.36/m	\$362.34/m
Each Add'l Ink	\$54.00	\$54.00	\$54.00	\$32.50/m	\$22.50/m	\$16.50/m	\$11.50/m
Sunscreen Lamination	\$182.00	\$182.00	\$182.00	\$107.00/m	\$85.50/m	\$80.00/m	\$54.00/m
Removable Stock Upgrade	\$41.00	\$41.00	\$72.00	\$66.00/m	\$62.00/m	\$51.50/m	\$41.00/m

(P) Prices effective January 1, 2022.

Maximum of 3 colors

To ensure 24-Hour production, please submit print-ready artwork by 2pm CT to ship the following day.

Gloss Lamination is applied at no additional cost.

## Process Color Pricing • SHIPS IN 24-HOURS!

GROUP	100	250	500	1,000	2,000	3,000	5,000	10,000
P	\$462.24	\$487.08	\$613.98	\$757.08	\$489.78/m	\$400.14/m	\$325.62/m	\$201.42/m
Q	\$491.94	\$516.78	\$636.66	\$786.78	\$520.56/m	\$429.30/m	\$356.40/m	\$233.82/m
R	\$507.06	\$532.98	\$652.32	\$817.56	\$541.62/m	\$448.74/m	\$370.44/m	\$245.16/m
S	\$534.06	\$561.06	\$668.52	\$837.00	\$556.20/m	\$461.16/m	\$378.54/m	\$259.20/m
T	\$560.52	\$589.14	\$685.26	\$856.98	\$570.78/m	\$474.12/m	\$386.10/m	\$273.24/m
U	\$586.44	\$617.22	\$700.92	\$876.96	\$585.90/m	\$486.54/m	\$394.20/m	\$287.28/m
V	\$613.44	\$644.76	\$717.66	\$895.86	\$600.48/m	\$499.50/m	\$401.76/m	\$301.86/m
W	\$639.36	\$673.38	\$733.86	\$915.84	\$615.06/m	\$511.92/m	\$409.86/m	\$315.90/m
X	\$787.32	\$821.34	\$954.18	\$1,259.82	\$877.50/m	\$710.10/m	\$565.92/m	\$335.34/m
Sunscreen Lamination	\$182.00	\$182.00	\$182.00	\$182.00	\$107.00/m	\$85.50/m	\$80.00/m	\$54.00/m
Removable Stock Upgrade	\$41.00	\$41.00	\$41.00	\$72.00	\$66.00/m	\$62.00/m	\$51.50/m	\$41.00/m

(P) Prices effective January 1, 2022.

Provide print-ready file (EPS, PDF); sized to chosen label.

To ensure 24-Hour production, please submit print-ready artwork by 2pm CT to ship the following day.

Gloss Lamination is applied at no additional cost. Process Color inks are not fade-resistant.

# OUTDOOR OVALS & CIRCLES



**Quick tips to make your Label stand out and make an impact:**

- For ink choices, **see page 1a**. Stock choices below.
- White back-up is suggested on clear stocks, **see page 44**.
- Labels are provided on rolls. If individually cut labels are wanted, add a \$35.00 (V) cutting charge per order.
  - Minimum size is 2" x 2".
- **FREE** gloss lamination provides protection against moisture, scratching, & outside elements.
  - Matte lamination is available, if requested  
*Recommended if you plan to write on the label.*
- Adding sunscreen lamination protects your labels and may extend the fade resistance of some inks, depending on environment and usage.
- Consecutive numbering available, **see page 39**.



**Stock for rough & textured surfaces available. Call for a quote.**

## Outdoor Stocks

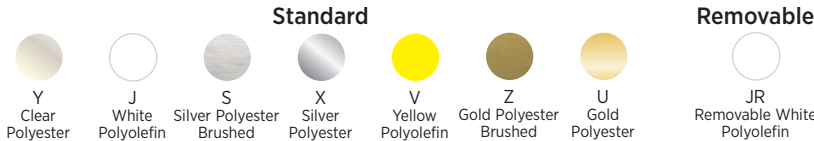

## Outdoor Ovals

SIZE	DIE	GROUP
3/4" x 1 1/2"	342	P
1" x 2"	308	P
1 1/4" x 2 1/2"	357	Q
1 5/8" x 3"	302	Q
2" x 3"	323	R
2 7/8" x 3 3/4"	303	U
4" x 6"	358	W

## Outdoor Circles

SIZE	DIE	GROUP
3/4"	443	P
1"	402	P
1 1/8"	439	P
1 1/2"	424	Q
1 3/4"	407	Q
2"	440	R
2 1/8"	444	R
2 1/4"	404	R
2 1/2"	401	S
3"	459	T
3 1/2"	460	U
4"	432	V
5"	468	W

**Looking for a unique size or shape?**  
See pages 22-24 for our *freemove™* laser cut labels.

## 1 Color 24-Hour Outdoor Ovals & Circles

Additional ink charges at bottom of price grid.

GROUP	250	500	1,000	2,000	3,000	5,000	10,000
P	\$192.24	\$262.98	\$355.86	\$213.84/m	\$163.08/m	\$118.26/m	\$83.70/m
Q	\$219.24	\$285.12	\$383.94	\$241.38/m	\$190.62/m	\$147.42/m	\$112.86/m
R	\$237.06	\$300.24	\$406.08	\$259.74/m	\$207.36/m	\$159.84/m	\$123.66/m
S	\$244.62	\$319.14	\$430.38	\$281.34/m	\$235.44/m	\$194.40/m	\$149.04/m
T	\$250.56	\$325.08	\$443.88	\$293.22/m	\$252.72/m	\$201.42/m	\$153.36/m
U	\$271.62	\$328.32	\$447.66	\$305.10/m	\$255.42/m	\$202.50/m	\$153.90/m
V	\$277.56	\$334.80	\$451.98	\$308.34/m	\$258.12/m	\$204.12/m	\$155.52/m
W	\$304.02	\$381.24	\$485.46	\$348.84/m	\$291.60/m	\$235.98/m	\$193.32/m
Each Add'l Ink	\$54.00	\$54.00	\$54.00	\$32.50/m	\$22.50/m	\$16.50/m	\$11.50/m
Sunscreen Lamination	\$182.00	\$182.00	\$182.00	\$107.00/m	\$85.50/m	\$80.00/m	\$54.00/m
Removable Stock Upgrade	\$41.00	\$41.00	\$72.00	\$66.00/m	\$62.00/m	\$51.50/m	\$41.00/m

(P) Prices effective January 1, 2022.

Maximum of 3 colors

To ensure 24-Hour production, please submit print-ready artwork by 2pm CT to ship the following day.

Gloss Lamination is applied at no additional cost.

## Process Color Pricing • SHIPS IN 24-HOURS!

GROUP	100	250	500	1,000	2,000	3,000	5,000	10,000
P	\$462.24	\$487.08	\$613.98	\$757.08	\$489.78/m	\$400.14/m	\$325.62/m	\$201.42/m
Q	\$491.94	\$516.78	\$636.66	\$786.78	\$520.56/m	\$429.30/m	\$356.40/m	\$233.82/m
R	\$507.06	\$532.98	\$652.32	\$817.56	\$541.62/m	\$448.74/m	\$370.44/m	\$245.16/m
S	\$534.06	\$561.06	\$668.52	\$837.00	\$556.20/m	\$461.16/m	\$378.54/m	\$259.20/m
T	\$560.52	\$589.14	\$685.26	\$856.98	\$570.78/m	\$474.12/m	\$386.10/m	\$273.24/m
U	\$586.44	\$617.22	\$700.92	\$876.96	\$585.90/m	\$486.54/m	\$394.20/m	\$287.28/m
V	\$613.44	\$644.76	\$717.66	\$895.86	\$600.48/m	\$499.50/m	\$401.76/m	\$301.86/m
W	\$639.36	\$673.38	\$733.86	\$915.84	\$615.06/m	\$511.92/m	\$409.86/m	\$315.90/m
Sunscreen Lamination	\$182.00	\$182.00	\$182.00	\$182.00	\$107.00/m	\$85.50/m	\$80.00/m	\$54.00/m
Removable Stock Upgrade	\$41.00	\$41.00	\$41.00	\$72.00	\$66.00/m	\$62.00/m	\$51.50/m	\$41.00/m

(P) Prices effective January 1, 2022.

Provide print-ready file (EPS, PDF); sized to chosen label.

To ensure 24-Hour production, please submit print-ready artwork by 2pm CT to ship the following day.

Gloss Lamination is applied at no additional cost. Process Color inks are not fade-resistant.





### Quick tips to make your Label stand out and make an impact:

- Also referred to as "butt cut" because labels are "butted" up next to each other without a gap in between.
- For ink choices, **see page 1a**. Stock choices, **see page 29**.
- To determine your square inches, multiply label width by height.
  - Minimum size square cut labels is 0.25" x 0.625"
  - One dimension must be a minimum of 0.625"
- White back-up is suggested on clear stocks, **see page 44**.
- Labels are provided on rolls. If individually cut labels are wanted, add a \$35.00 (V) cutting charge per order which includes:
  - Minimum size is 2" x 2".
  - Standard bend & peel, **see page 43 for example**.
  - Back slit available, if requested.
- **FREE** gloss lamination provides protection against moisture, scratching, and outside elements.
  - Matte lamination is available, if requested.  
*Recommended if you plan to write on the label.*
- Adding sunscreen lamination protects your labels and may extend the fade resistance of some inks, depending on environment and usage.
- Artwork and copy should be 1/8" from all edges.  
*If bleeds are needed, please ask for pricing.*

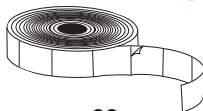

### 1 Color 24-Hour Outdoor Square Cut

Additional ink charges at bottom of price grid.

SQUARE INCHES	250	500	1,000	2,000	3,000	5,000	10,000
Up to 1.49	\$201.96	\$237.06	\$285.12	\$188.46/m	\$147.96/m	\$109.62/m	\$77.22/m
1.5 to 2.49	\$206.28	\$241.92	\$292.68	\$195.48/m	\$158.76/m	\$116.10/m	\$79.38/m
2.5 to 3.49	\$213.84	\$251.64	\$305.64	\$215.46/m	\$167.94/m	\$119.34/m	\$84.24/m
3.5 to 4.49	\$219.24	\$258.66	\$312.66	\$219.78/m	\$175.50/m	\$124.74/m	\$85.86/m
4.5 to 5.49	\$221.94	\$263.52	\$328.86	\$247.32/m	\$196.02/m	\$145.26/m	\$101.52/m
5.5 to 6.49	\$226.26	\$268.38	\$332.10	\$248.94/m	\$198.18/m	\$147.42/m	\$102.60/m
6.5 to 7.49	\$230.04	\$273.78	\$340.20	\$254.88/m	\$203.58/m	\$151.74/m	\$108.54/m
7.5 to 8.99	\$243.00	\$289.98	\$363.96	\$266.22/m	\$217.08/m	\$170.64/m	\$125.82/m
9 to 12.99	\$254.34	\$311.58	\$397.98	\$299.70/m	\$248.40/m	\$199.26/m	\$160.38/m
13 to 16.99	\$271.08	\$332.10	\$423.36	\$316.44/m	\$264.60/m	\$216.54/m	\$174.96/m
17 to 21.25	\$288.36	\$356.40	\$457.92	\$366.66/m	\$304.02/m	\$247.32/m	\$201.42/m
21.26 to 24.99	\$335.34	\$424.98	\$551.34	\$474.12/m	\$401.76/m	\$342.36/m	\$296.46/m
25 to 29.99	\$355.32	\$463.32	\$641.52	\$563.22/m	\$496.80/m	\$433.08/m	\$375.30/m
Each Add'l Ink	\$54.00	\$54.00	\$54.00	\$32.50/m	\$22.50/m	\$16.50/m	\$11.50/m
Sunscreen Lamination	\$182.00	\$182.00	\$182.00	\$107.00/m	\$85.50/m	\$80.00/m	\$54.00/m
Removable Stock Upgrade	\$41.00	\$41.00	\$72.00	\$66.00/m	\$62.00/m	\$51.50/m	\$41.00/m

(P) Prices effective January 1, 2022.  
Maximum of 3 colors

To ensure 24-Hour production, please submit print-ready artwork by 2pm CT to ship the following day.  
Gloss Lamination is applied at no additional cost.

### Process Color Pricing • SHIPS IN 24-HOURS!

SQUARE INCHES	100	250	500	1,000	2,000	3,000	5,000	10,000
Up to 4.99	\$511.92	\$537.30	\$594.54	\$733.32	\$433.08/m	\$326.70/m	\$238.14/m	\$156.06/m
5 to 7.49	\$537.84	\$565.92	\$628.02	\$784.08	\$503.28/m	\$395.28/m	\$306.18/m	\$196.02/m
7.5 to 10.49	\$545.40	\$578.34	\$644.22	\$805.14	\$548.64/m	\$462.78/m	\$345.60/m	\$216.00/m
10.5 to 16.49	\$619.38	\$657.72	\$740.34	\$933.12	\$633.42/m	\$516.78/m	\$411.48/m	\$270.54/m
16.5 to 20.49	\$642.06	\$682.56	\$770.04	\$981.18	\$665.82/m	\$559.44/m	\$435.24/m	\$305.64/m
20.5 to 24	\$801.36	\$866.16	\$935.28	\$1,267.92	\$845.64/m	\$699.84/m	\$574.56/m	\$432.00/m
24.01 to 28	\$868.32	\$941.22	\$1,088.64	\$1,427.76	\$1,137.78/m	\$851.58/m	\$686.88/m	\$521.64/m
Sunscreen Lamination	\$182.00	\$182.00	\$182.00	\$182.00	\$107.00/m	\$85.50/m	\$80.00/m	\$54.00/m
Removable Stock Upgrade	\$41.00	\$41.00	\$41.00	\$72.00	\$66.00/m	\$62.00/m	\$51.50/m	\$41.00/m

(P) Prices effective January 1, 2022.  
Provide print-ready file (EPS, PDF); sized to chosen label.

To ensure 24-Hour production, please submit print-ready artwork by 2pm CT to ship the following day.  
Gloss Lamination is applied at no additional cost. Process Color inks are not fade resistant.

# REFLECTIVE LABELS

## Quick tips to make your Label stand out and make an impact:

- For ink choices, see page 1a. See stock below.
- Retro-reflective stock is great for high visibility in low-light, dark conditions or poor weather conditions.
- Used for safety decals, warning/security stickers, hard hat stickers, parking permits and warehouse rack labels.
- Stock appears slightly grey in color.
- Please note, your imprint will block out the reflectivity of the stock in that area.
- Labels provided on rolls. If individually cut labels are wanted, add a \$35.00 (V) cutting charge per order.
  - Minimum size is 2" x 2".
- **FREE** gloss lamination provides protection against moisture, scratching and outside elements.
  - Matte lamination is available, if requested.
- Adding sunscreen lamination protects your labels and may extend the fade resistance of some inks, depending on environment and usage.
- Can be used in applications requiring long-range scannable barcodes.
- Static barcodes are no additional charge. *If the barcode is a different color than the rest of the imprint, add'l ink charge applies. See page 40.*
- Consecutive numbering available, see page 39.



### Reflective Label Stock



### 1 Color Reflective Labels

Additional ink charges at bottom of price grid.

SIZE Shape	DIE	100	250	500	1,000	2,000	3,000	5,000	10,000
1 1/2" x 2 1/2" Rectangle	195	\$373.68	\$426.06	\$537.30	\$709.02	\$509.76/m	\$507.06/m	\$454.68/m	\$320.22/m
2" x 3" Rectangle	145	\$419.58	\$470.88	\$611.82	\$816.48	\$624.78/m	\$529.74/m	\$510.30/m	\$464.94/m
2" x 4" Rectangle	127	\$436.86	\$484.92	\$621.00	\$876.96	\$646.38/m	\$585.90/m	\$543.24/m	\$510.30/m
2 1/2" x 3 1/2" Rectangle	160	\$436.86	\$484.92	\$621.00	\$876.96	\$646.38/m	\$585.90/m	\$543.24/m	\$510.30/m
3" x 4" Rectangle	1212	\$455.22	\$584.28	\$774.90	\$1,161.00	\$881.82/m	\$803.52/m	\$762.48/m	\$731.16/m
3" x 5" Rectangle	1213	\$455.22	\$584.28	\$774.90	\$1,161.00	\$881.82/m	\$803.52/m	\$762.48/m	\$731.16/m
3 1/2" x 4 1/2" Rectangle	1232	\$542.16	\$771.12	\$1,121.58	\$1,742.04	\$1,486.08/m	\$1,413.72/m	\$1,359.72/m	\$793.80/m
4" x 6" Rectangle	185	\$555.66	\$793.26	\$1,136.70	\$1,807.38	\$1,563.30/m	\$1,443.96/m	\$1,431.54/m	\$1,140.48/m
5" x 8" Rectangle	9452	\$663.66	\$1,057.32	\$1,711.80	\$3,022.38	\$2,839.32/m	\$2,793.96/m	\$2,748.60/m	\$2,732.94/m
2" x 2" Square	202	\$373.68	\$426.06	\$537.30	\$709.02	\$509.76/m	\$507.06/m	\$454.68/m	\$320.22/m
2 1/2" x 2 1/2" Square	204	\$419.58	\$470.88	\$611.82	\$816.48	\$624.78/m	\$529.74/m	\$510.30/m	\$464.94/m
3" x 3" Square	203	\$436.86	\$484.92	\$621.00	\$876.96	\$646.38/m	\$585.90/m	\$543.24/m	\$510.30/m
3 1/2" x 3 1/2" Square	254	\$455.22	\$584.28	\$774.90	\$1,161.00	\$881.82/m	\$803.52/m	\$762.48/m	\$731.16/m
4" x 4" Square	205	\$542.16	\$771.12	\$1,121.58	\$1,742.04	\$1,486.08/m	\$1,413.72/m	\$1,359.72/m	\$793.80/m
2" x 3" Oval	323	\$419.58	\$470.88	\$611.82	\$816.48	\$624.78/m	\$529.74/m	\$510.30/m	\$464.94/m
2" x 4" Oval	362	\$436.86	\$484.92	\$621.00	\$876.96	\$646.38/m	\$585.90/m	\$543.24/m	\$510.30/m
4" x 6" Oval	358	\$555.66	\$793.26	\$1,136.70	\$1,807.38	\$1,563.30/m	\$1,443.96/m	\$1,431.54/m	\$1,140.48/m
1 1/2" Circle	424	\$370.98	\$392.58	\$490.86	\$652.32	\$453.60/m	\$407.16/m	\$352.62/m	\$314.82/m
2" Circle	440	\$373.68	\$426.06	\$537.30	\$709.02	\$509.76/m	\$507.06/m	\$454.68/m	\$320.22/m
2 1/2" Circle	401	\$419.58	\$470.88	\$611.82	\$816.48	\$624.78/m	\$529.74/m	\$510.30/m	\$464.94/m
3" Circle	459	\$436.86	\$484.92	\$621.00	\$876.96	\$646.38/m	\$585.90/m	\$543.24/m	\$510.30/m
3 1/2" Circle	460	\$455.22	\$584.28	\$774.90	\$1,161.00	\$881.82/m	\$803.52/m	\$762.48/m	\$731.16/m
4" Circle	432	\$542.16	\$771.12	\$1,121.58	\$1,742.04	\$1,486.08/m	\$1,413.72/m	\$1,359.72/m	\$793.80/m
<b>Each Add'l Ink</b>		<b>\$54.00</b>	<b>\$54.00</b>	<b>\$54.00</b>	<b>\$54.00</b>	<b>\$32.50/m</b>	<b>\$22.50/m</b>	<b>\$16.50/m</b>	<b>\$11.50/m</b>
<b>Sunscreen Lamination</b>		<b>\$182.00</b>	<b>\$182.00</b>	<b>\$182.00</b>	<b>\$182.00</b>	<b>\$107.00/m</b>	<b>\$85.50/m</b>	<b>\$80.00/m</b>	<b>\$54.00/m</b>

(P) Prices effective January 1, 2022. Maximum of 3 colors

Production Time: 1 or 2 Color - 24-Hour; 3 Color - 2 Working Days. To ensure 24-Hour production, please submit print-ready artwork by 2pm CT to ship the following day. Gloss Lamination is applied at no additional cost. Process Color inks are not fade-resistant.

## Quick tips to make your Label stand out and make an impact:

- For ink choices, see page 1a. Stock choices below.
- **FREE** gloss lamination provides protection against moisture, scratching, and outside elements.
  - Matte lamination is available, if requested.  
*Recommended if you plan to write on the label.*
- Adding sunscreen lamination protects your labels and may extend the fade resistance of some inks, depending on environment and usage.  
*See price grid below for additional charge.*
- Static barcodes are no additional charge.  
*If the barcode is a different color than the rest of the imprint, add'l ink charge applies. See page 40.*
  - If a variable barcode is wanted, please call for pricing.
- Consecutive numbering, see price grid below.
  - Please indicate imprint color and starting number.
  - Supplied on rolls only (not available as individual labels).

Example:

1



001



0001



## Asset Stocks

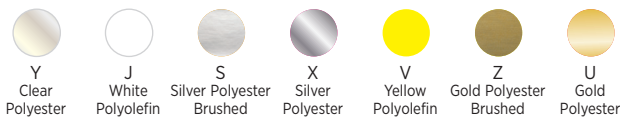

## 1 Color Pricing

Additional ink charges at bottom of price grid.

SIZE Shape	DIE	250	500	1,000	2,000	3,000	5,000	10,000
½" x 1 ½" Rectangle	1312	\$192.24	\$262.98	\$355.86	\$213.84/m	\$163.08/m	\$118.26/m	\$83.70/m
½" x 2" Rectangle	107	\$192.24	\$262.98	\$355.86	\$213.84/m	\$163.08/m	\$118.26/m	\$83.70/m
¾" x 1 ½" Rectangle	108	\$192.24	\$262.98	\$355.86	\$213.84/m	\$163.08/m	\$118.26/m	\$83.70/m
¾" x 2" Rectangle	109	\$192.24	\$262.98	\$355.86	\$213.84/m	\$163.08/m	\$118.26/m	\$83.70/m
¾" x 2 ½" Rectangle	1238	\$192.24	\$262.98	\$355.86	\$213.84/m	\$163.08/m	\$118.26/m	\$83.70/m
1" x 2" Rectangle	155	\$192.24	\$262.98	\$355.86	\$213.84/m	\$163.08/m	\$118.26/m	\$83.70/m
1" x 3" Rectangle	1242	\$219.24	\$285.12	\$383.94	\$241.38/m	\$190.62/m	\$147.42/m	\$112.86/m
1 ½" x 3" Rectangle	148	\$219.24	\$285.12	\$383.94	\$241.38/m	\$190.62/m	\$147.42/m	\$112.86/m
<b>Each Add'l Ink</b>		<b>\$54.00</b>	<b>\$54.00</b>	<b>\$54.00</b>	<b>\$32.50/m</b>	<b>\$22.50/m</b>	<b>\$16.50/m</b>	<b>\$11.50/m</b>
<b>Sunscreen Lamination</b>		<b>\$182.00</b>	<b>\$182.00</b>	<b>\$182.00</b>	<b>\$107.00/m</b>	<b>\$85.50/m</b>	<b>\$80.00/m</b>	<b>\$54.00/m</b>

(P) Prices effective January 1, 2022.  
Maximum of 3 colors

Production Time: 1 or 2 Color - 24-Hour; 3 Color - 2 Working Days. Gloss lamination is applied at no additional cost.  
To ensure 24-Hour production, please submit print-ready artwork by 2pm CT to ship the following day.

## Consecutive Numbering Upcharge

	250	500	1,000	2,000	3,000	5,000	10,000
	\$92.50	\$92.50	\$92.50	\$99.75	\$107.00	\$121.50	\$157.75

(V) Prices effective January 1, 2022.

# PINFED LABELS



**Quick tips to make your Label stand out and make an impact:**

- For ink choices, see page 1a. Stock choices below.
- Dot matrix continuous labels are used with dot matrix printers and computers.
- These labels easily fold into an organized stack with its fanfold and perforated finish, which allows for a clean tear of the detachable label after one is used. *Example pictured below.*
- Images not shown to actual size.

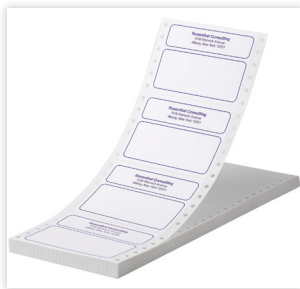
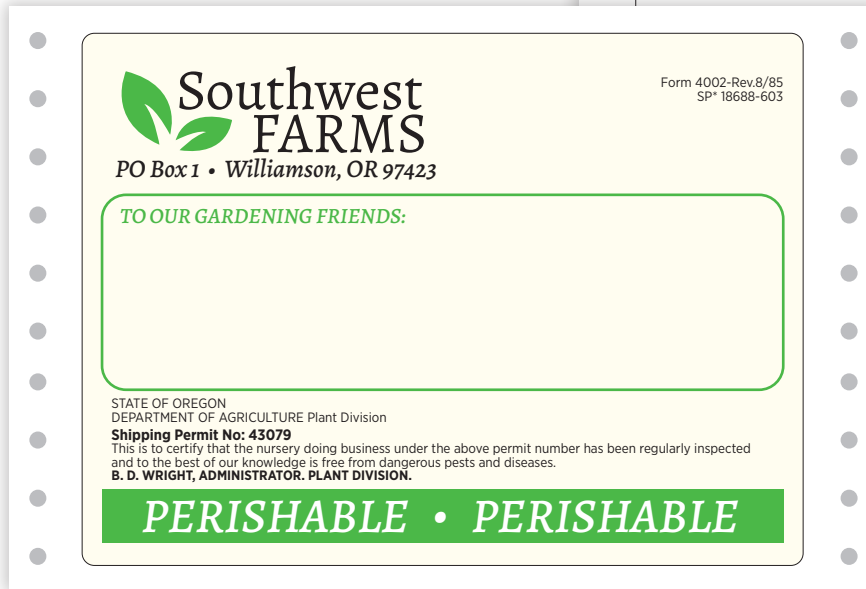
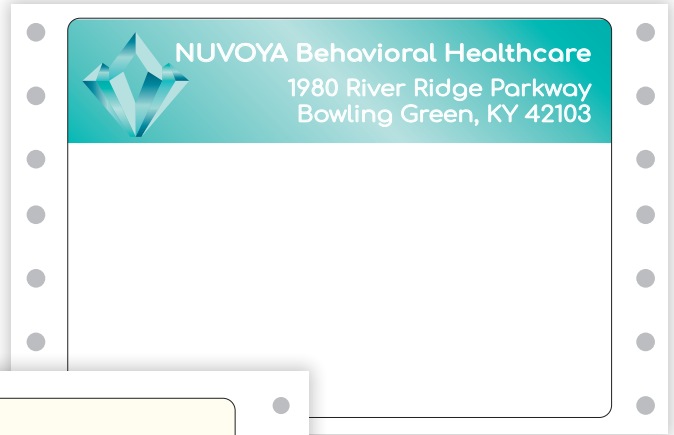

**Pinfed Stocks**

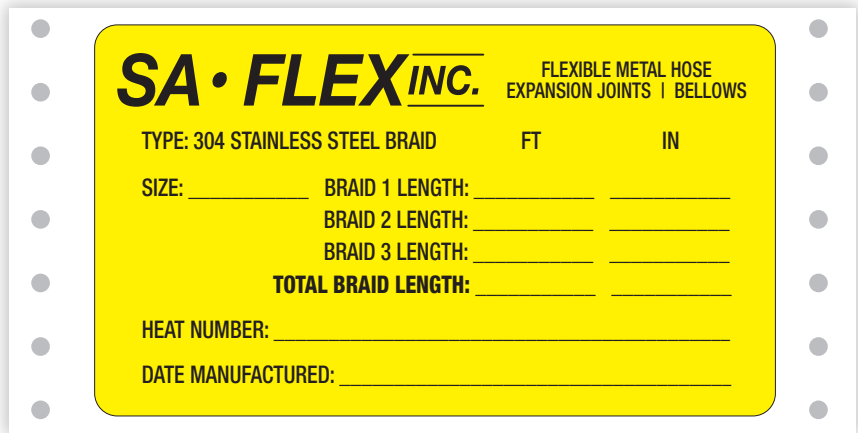

**1 Color Pricing**

Additional ink charges at bottom of price grid.

SIZE	DIE	500	1,000	2,000	3,000	5,000	10,000
2 7/8" x 4 1/4"	122	\$166.32	\$207.36	\$167.40/m	\$148.50/m	\$122.58/m	\$95.04/m
2 7/8" x 5"	115	\$169.56	\$212.22	\$170.10/m	\$155.52/m	\$129.06/m	\$99.36/m
2 15/16" x 4"	114	\$166.32	\$207.36	\$167.40/m	\$148.50/m	\$122.58/m	\$95.04/m
3 3/8" x 5 1/2"	125	\$273.24	\$335.34	\$226.80/m	\$189.00/m	\$157.68/m	\$129.06/m
3 7/8" x 5 1/4"	105	\$273.24	\$335.34	\$226.80/m	\$189.00/m	\$157.68/m	\$129.06/m
3 15/16" x 6"	150	\$273.24	\$335.34	\$226.80/m	\$189.00/m	\$157.68/m	\$129.06/m
<b>Each Add'l Ink</b>		<b>\$54.00</b>	<b>\$54.00</b>	<b>\$32.50/m</b>	<b>\$22.50/m</b>	<b>\$16.50/m</b>	<b>\$11.50/m</b>

(P) Prices effective January 1, 2022. Maximum of 3 colors.

Production Time: 1 or 2 Color - 24-Hour; 3 Color - 2 Working Days. To ensure 24-Hour production, please submit print-ready artwork by 2pm CT to ship the following day.

### Quick tips to make your Label stand out and make an impact:

- For ink choices, see page 1a. Stock choices below.
- Black ink for text color is recommended on Fluorescent stock for readability on the label.
- White Laser stock is also compatible with inkjet printers.
- Laser sheets feature permanent acrylic adhesive, which is resistant to high temperatures so it won't damage printers.
- Compatible with popular software programs.

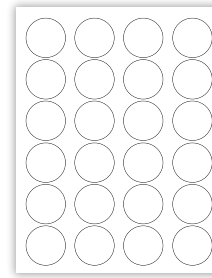

**Die 566** 24-up  
1 2/3" diameter  
*bleeds available*

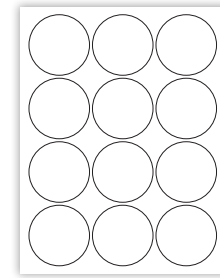

**Die 595** 12-up  
2 1/2" diameter  
*bleeds available*

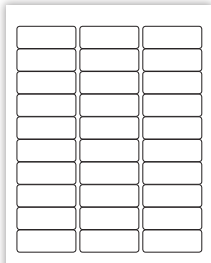

**Die 562** 30-up  
1" x 2 5/8"

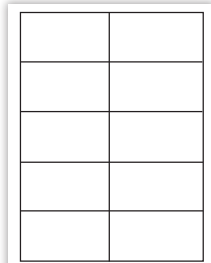

**Die 1510** 10-up  
2" x 3 1/2"

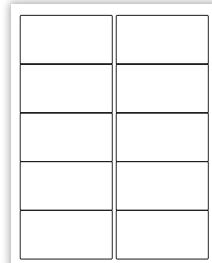

**Die 564** 10-up   
2" x 4"

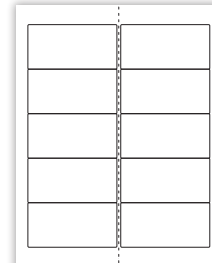

**Die 591** 10-up with perf  
2" x 4"

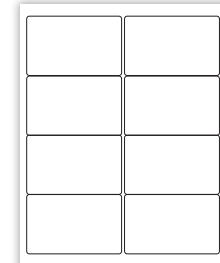

**Die 508** 8-up  
2 1/2" x 4"

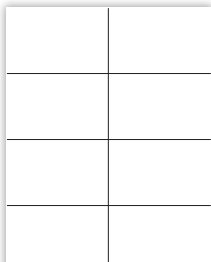

**Die 567** 8-up  
2 3/4" x 4 1/4"

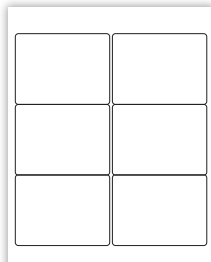

**Die 581** 6-up  
3" x 4"

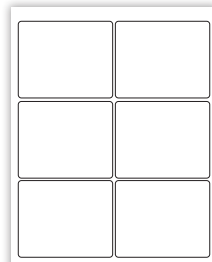

**Die 513** 6-up  
3 1/4" x 4"  
*bleeds available*

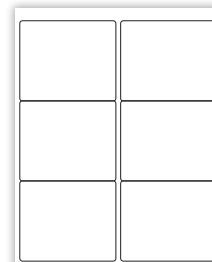

**Die 506** 6-up   
3 1/3" x 4"

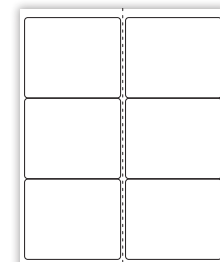

**Die 594** 6-up perf  
3 1/3" x 4"

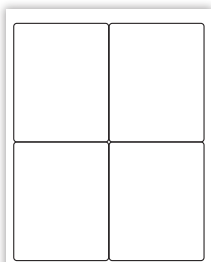

**Die 1517** 4-up  
4" x 5"

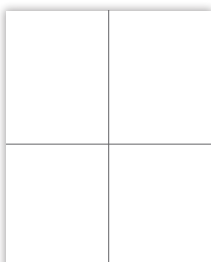

**Die 585** 4-up   
4 1/4" x 5 1/2"



**Die 1512** 3-up  
3 1/2" x 8 1/2"

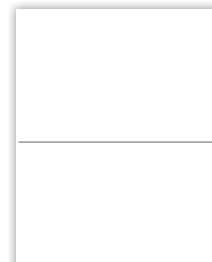

**Die 586** 2-up  
5 1/2" x 8 1/2"

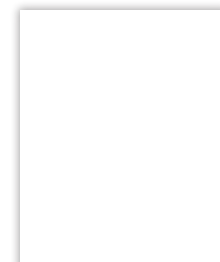

**Die 576** 1-up   
8 1/2" x 11"  
*comes with a back slit*

### Laser Sheet Stocks

<b>Standard</b>						<b>Removable</b>
L White Laser	FG Green Fluorescent	FN Orange Fluorescent	FP Pink Fluorescent	FC Chartreuse Fluorescent	FR Red Fluorescent	RZ White Removable

### Laser Sheet Labels • SHIPS IN 24-HOURS!

IMPRINT	100 Sheets	200 Sheets	300 Sheets	400 Sheets	500 Sheets	1,000 Sheets	1,500 Sheets	2,000 Sheets
<b>Blank</b>	\$51.84/lot	\$84.24/lot	\$112.86/lot	\$132.84/lot	\$150.12/lot	\$228.96/lot	\$327.78/lot	\$427.68/lot
<b>1 Color</b>	\$156.60/lot	\$240.84/lot	\$297.00/lot	\$328.86/lot	\$358.02/lot	\$493.56/lot	\$678.78/lot	\$864.54/lot
<b>2 Color</b>	\$235.44/lot	\$360.18/lot	\$432.54/lot	\$461.70/lot	\$489.24/lot	\$611.28/lot	\$801.90/lot	\$992.52/lot
<b>3 Color</b>	\$270.54/lot	\$366.12/lot	\$459.54/lot	\$550.26/lot	\$623.70/lot	\$927.18/lot	\$1,036.80/lot	\$1,145.34/lot

(P) Prices effective January 1, 2022.

Production Time: 1 or 2 Color - 24-Hour; 3 Color - 2 Working Days.  
To ensure 24-Hour production, please submit print-ready artwork by 2pm CT to ship the following day.

# DESIGNER MAILING LABELS



## Quick tips to make your Label stand out and make an impact:

- Available in various colors and styles that are reliable and unique.
- Add your logo and/or 4 lines of personalization at no charge  
Unless otherwise specified, personalization will be typeset as follows:

Mainline - **Helvetica Neue LT Std Bold**

Body - Helvetica Neue LT Std Roman

- Imprint available in one color only.  
**See page 1a for ink choices.**
- Bleeds and screens are not available.

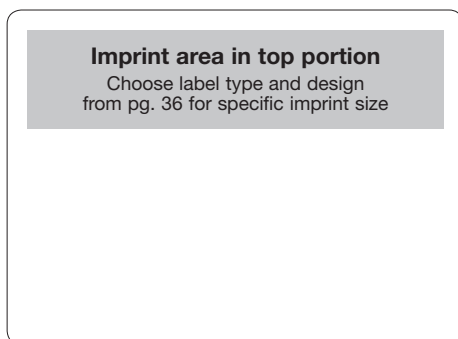

## TYPES OF MAILING LABELS:

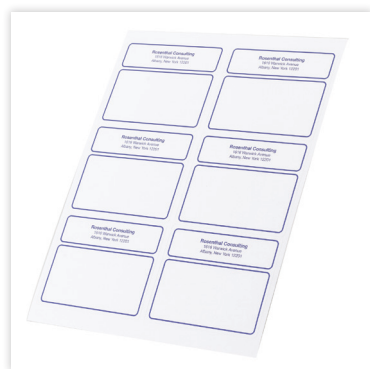

### Laser/Inkjet Sheets

- White Laser stock (L)
- Label size: 3 1/3" x 4"
- 8 1/2" x 11" sheet, 6-up
- For laser or inkjet printers



### Rolls

- White Matte stock (G)
- Label size: 2 15/16" x 4"
- Perforated between each label
- For typewriters or handwriting

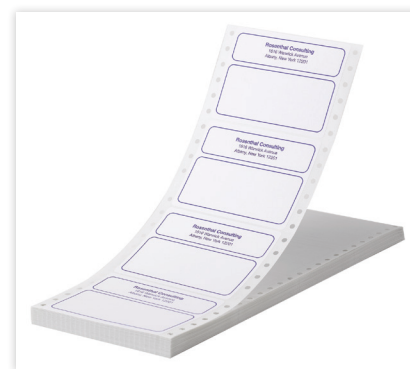

### Pinfed - Fanfolded

- White EDP stock (H)
- Label size: 2 15/16" x 4"
- Perforated between each label
- For dot matrix computer printers

## Roll & Pinfed Pricing • SHIPS IN 24-HOURS!

Imprint	SIZE	250	500	1,000	2,000	3,000	5,000	10,000
Blank	2 15/16" x 4"	\$58.86	\$65.34	\$78.30	\$71.28/m	\$65.34/m	\$56.70/m	\$47.52/m
1 Color	2 15/16" x 4"	\$73.98	\$81.00	\$98.82	\$87.48/m	\$79.92/m	\$70.20/m	\$59.94/m

(P) Prices effective January 1, 2022.

Production Time: Blank or 1 Color - 24-Hour  
To ensure 24-Hour production, please submit print-ready artwork by 2pm CT to ship the following day.

## Laser / Inkjet Pricing • SHIPS IN 24-HOURS!

Imprint	SIZE	100 Sheets	200 Sheets	300 Sheets	400 Sheets	500 Sheets	1,000 Sheets
Blank	3 1/3" x 4"	\$61.02/lot	\$92.88/lot	\$117.18/lot	\$143.64/lot	\$165.78/lot	\$265.14/lot
1 Color	3 1/3" x 4"	\$89.64/lot	\$131.22/lot	\$170.10/lot	\$206.82/lot	\$240.84/lot	\$403.92/lot

(P) Prices effective January 1, 2022.

Production Time: Blank or 1 Color - 24-Hour  
To ensure 24-Hour production, please submit print-ready artwork by 2pm CT to ship the following day.

**Label Size:** Laser/Inkjet Sheets: 3 1/3" x 4"    Rolls: 2 15/16" x 4"    Pinfed-Fanfold: 2 15/16" x 4"

**Design 2**

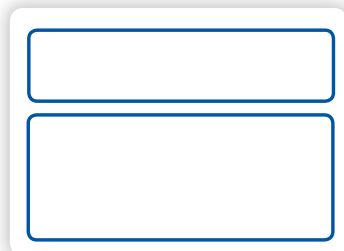

Imprint Size  
Roll/Pinfed 1 1/16" x 3 1/2"  
Laser Sheet 3/4" x 3 5/8"

**Design 3**

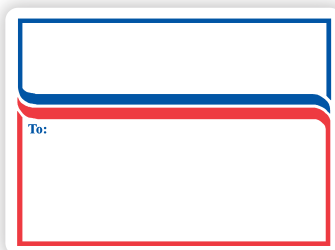

Imprint Size  
Roll/Pinfed 7/8" x 3 1/2"  
Laser Sheet 3/4" x 3 1/2"

**Design 7**

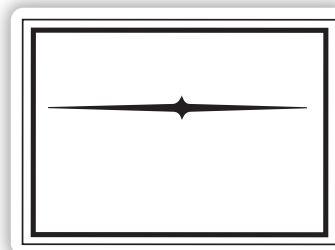

Imprint Size  
Roll/Pinfed 3/4" x 3 7/16"  
Laser Sheet 7/8" x 3 3/8"

**Design 8**

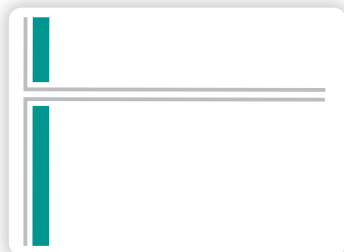

Imprint Size  
Roll/Pinfed 3/4" x 3 1/2"  
Laser Sheet 1" x 3 1/2"

**Design 11**

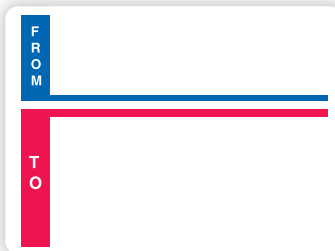

Imprint Size  
Roll/Pinfed 3/4" x 3 1/4"  
Laser Sheet 7/8" x 3 1/8"

**Design 15**

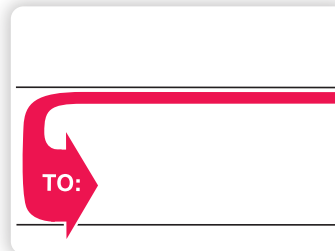

Imprint Size  
Roll/Pinfed 15/16" x 3 7/8"  
Laser Sheet 1" x 3 7/8"

**Design 19**

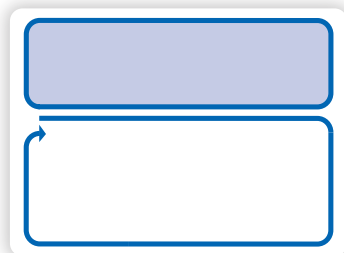

Imprint Size  
Roll/Pinfed 7/8" x 3 5/8"  
Laser Sheet 7/8" x 3 9/16"

**Design 21**

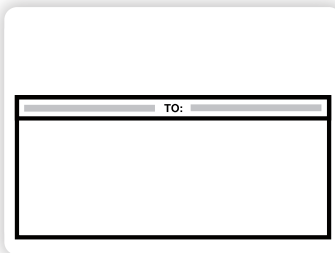

Imprint Size  
Roll/Pinfed 1 1/16" x 3 7/8"  
Laser Sheet 13/16" x 3 7/8"

**Design 22**



Imprint Size  
Roll/Pinfed 3/4" x 3 3/8"  
Laser Sheet 1" x 3 3/8"

**Design 23**



Imprint Size  
Roll/Pinfed 1 1/16" x 3 1/2"  
Laser Sheet 1 1/16" x 3 1/2"

**Design 24**



Imprint Size  
Roll/Pinfed 1 1/16" x 3 7/16"  
Laser Sheet 7/8" x 3 1/2"

**Design 25**

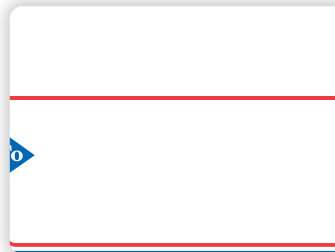

Imprint Size  
Roll/Pinfed 13/16" x 3 7/16"  
Laser Sheet 3/4" x 3 7/16"

# FOLDED CARTONS New!

Label Works has provided expertise in pressure sensitive labels, stickers and decals for over 30 years. Our operational excellence and superb customer service and support keep our customers coming back project after project and year after year. It is with this same level of dedication and commitment we are now adding packaging to compliment your products and brand. We will work with you on all your label and packaging project needs and make sure your brand gets eye-popping shelf appeal and stands out front and center from all the rest. We've been labeling products and brands for many years, now we are packaging them too.

Your Brand. Your Product. Packaged to Perfection.

**Labels:**

Your brand and product are important and complementing your label with a package presentation will make a memorable lasting impression.

**Packaging:**

Protect your brand with the perfect package. We offer exceptionally engineered packaging solutions that protect contents, safeguard users and enhance shelf appeal.



- Your label says a lot about your brand and a package can extend your messaging and make a lasting impression.
- Packaging serves a purpose. It protects, attracts attention, adds impact, and provides additional information on what is inside.
- Packaging is an extension of your brand and marketing presentation. It gets customers to stop and engage with your product.
- Having an appealing package design will make your product stand out above the rest and increase sales potential.
- A cohesive label and package presentation is impactful and will ensure your brand will be remembered in the minds of your customers.







## Packaging Importance:

Your package is the first impression your brand makes with the consumer. We will work with you to make sure it is designed to reflect your brand message and identity and start the relationship bond to give your products preference above the rest.

## Why Flexible Packaging?

Be a part of this growing trend in packaging that is driven by innovation and technology and gaining increased popularity among consumers and brand managers alike. Flexible packaging delivers so much more and will help you gain new customers as well as long lasting loyal buyers.

**Consumers love it** - Offering excellent shelf-appeal with high-quality, attention-grabbing and complete package designs that accommodate your needs.

**Convenience is Key** - Space-saving package designs with resealable closures so your package can be used and reused.

**Conserves resources** - Great for our environment, packages are produced with less plastic, water and energy, and fewer greenhouse gas emissions.

**Cost efficient** - This lightweight package is easier and more affordable to transport, volumes can be increased and is less likely to be damaged during the shipping process.

**Complete customization** - Build consumer confidence in your brand with your unique, consistent message.

## Product Offering

**Lay Flat Pouches** - are a great solution for small portion or single serve packaging opportunities. They may be small in size, but can really get attention with high quality designs that will showcase your brand perfectly.



**Stand Up Pouches** - will definitely get your product and brand noticed on the shelf. They stand unattended and seek to engage the consumer as they pass by with creative, eye-catching designs. They make a powerful statement with the durable bottom gusset that gives it strength and allows you to package larger and heavier products.



# VARIABLE PRINTING

## Helpful Information

### What is Variable Printing?

Have the ability to change something from label to label in the same spot to personalize or show data when printing. Text, images, barcodes, numbering, colors or a combination of these can all be changed on the label.

### Add value to your labels:

Digitally printed labels allow you to customize each label with a unique message, promotional code or number sequence.

## Variable Data & Imaging

- Variable labels are easy to order, just provide the following:
    - A composite proof of the label
    - All art or images that will be on the label
    - An Excel spreadsheet of the variable information
- Row one of the spreadsheet should describe each **column** of information.

1	Years Accident Free
2	OneYear.eps
3	TwoYears.eps
4	ThreeYears.eps
5	FourYears.eps
6	FiveYears.eps
7	SixYears.eps



## Types of Variable Labels



### Personalization

Create personalized messages by highlighting names, purchasing habits or address information on targeted promotions and marketing campaigns.



### Variable Data

Unique numbering patterns, sequence of letters & numbers and certain barcodes are used to identify product lines, provide custom log-ins and track work-in-progress, goods received and promotions.

**PLEASE ASK TO DISCUSS THE BEST OPTIONS AND PRICING FOR YOUR PROJECT!**

## CONSECUTIVE NUMBERING

- Available on most stocks
- Supplied on rolls. Call for pricing if individually cut labels are needed.
  - If a certain number of labels per roll are needed, additional charges may apply.
- Please indicate number imprint color and a starting number
 

Example: 1  
01  
001
- Add consecutive numbering upcharge to base price



### Consecutive Numbering Upcharge

100	250	500	1,000	2,000	3,000	5,000	10,000	15,000	20,000	25,000
\$92.50	\$92.50	\$92.50	\$99.75	\$107.00	\$121.50	\$157.75	\$194.00	\$230.25	\$266.50	\$266.50

(V) Prices effective January 1, 2022.









## Quick tips to make your Label stand out and make an impact:

- Static barcodes are no additional charge.
  - If the barcode is a different color than the rest of the imprint, additional ink charge applies.
- Variable barcodes require a charge, ask for pricing if needed.
- Black or dark inks are recommended.
- White stock is highly recommended.
  - Clear stock may be used depending on the color of the application surface.
- Red Fluorescent, Gold, Silver, White EDP and Laser stocks are not recommended, due to possible scanning problems.



## Generating a Barcode - What is Needed:

- Select type of code, such as Code 39.
- Indicate characters to encode.
- Choose size (under 3/8" height not recommended).
- **For consecutive or variable barcodes, please supply data file. Ask for pricing.**

TYPES OF BARCODES	SYMBOL	CHARACTER SET	LENGTH	APPLICATIONS/COMMENTS
<b>Code 39</b> <i>variable barcoding available</i>	 0123456ABC	Uppercase letters A-Z; Numbers 0-9 Space -, \$ ? + %	Varies	Widely used; excellent for many applications
<b>Code 128</b> <i>variable barcoding available</i>	 01234567890	All ASCII* characters and control codes	Varies	Widely used; excellent for many applications
<b>GSI-128</b> <i>formerly UCC/EAN-128</i>	 (01)123456789	All ASCII* characters and control codes	Varies	Subset of Code 128 which defines data formats for commerce
<b>EAN-13</b>	 01123456789012	Numbers Only	13+ Check Digit +2 optional +5 optional	Most widely used retail product marking worldwide
<b>EAN-8</b>	 01234565	Numbers Only	7+ Check Digit	Retail product marking worldwide; compressed code for products with limited label space
<b>UPC-A</b>	 012345678905	Numbers Only	11+ Check Digit +2 optional +5 optional	Retail product marking in USA and Canada
<b>UPC-E</b>	 01234565	Numbers Only	7 + Check Digit	Retail product marking in USA and Canada; compressed code for products with limited label space
<b>Interleaved 2 of 5</b> <i>variable barcoding available</i>	 1234567890	Numbers Only	Varies	Very compact; encodes digits in pairs so total length must be an even number of digits
<b>QR Code</b>		All ASCII* Characters	Varies	2D barcode

\*ASCII (American Standard Code for Information Interchange) is a character-encoding system. The codes represent data (numbers or text) read by computers and other devices.

## STOCK REFERENCE GUIDE

STOCK	STOCK CODE	DESCRIPTION	INDOOR/ OUTDOOR	APPLICATION & SERVICE TEMP
White Gloss Yellow Gloss Ivory Gloss Black Gloss Forest Green Gloss	A B BC O P	The glossy, smooth surface of this versatile stock makes the colors on the label shine. <ul style="list-style-type: none"> <li>• Semi-gloss paper stock for high-quality detail reproduction</li> <li>• Add foil stamping to your label to capture the eye of the consumer with extra shine</li> <li>• Not recommended for write on additions to the label</li> </ul>	Indoor	-20°F min. -65°F to +200°F
White Gloss Removable  White Matte Removable	AS  BF	Removable adhesive allows you to have the freedom to reposition your label anytime with a clean peel away and sticks right back on a location. <ul style="list-style-type: none"> <li>• White gloss is a semi-gloss paper stock for high quality detailed reproduction. White matte is a coated paper stock</li> <li>• Features general purpose removable adhesive</li> <li>• Excellent long-term removability from a wide variety of surfaces</li> <li>• Suitable for most surfaces, including: glass, plastics, and corrugated cardboard</li> </ul>	Indoor	+25°F min. -40°F to +200°F  +40°F min. -65°F to +180°F
White Gloss Blockout White Matte Blockout <i>(Also known as Opaque)</i>	Q R	<ul style="list-style-type: none"> <li>• Blockout is designed to cover up mistakes and block out copy from showing through the label</li> <li>• Permanent adhesive (hide those mistakes FOR GOOD!)</li> </ul>	Indoor	-20°F min. -65°F to +200°F
White Matte Yellow Matte Ivory Matte <i>(Also known as Matte Litho or Offset)</i>	G AM BH	Sometimes simple is better. Matte is as uncomplicated as stock choices come. <ul style="list-style-type: none"> <li>• A high quality, coated stock that works hard and looks great!</li> <li>• Provides excellent printability and color clarity</li> <li>• Easy to write on</li> </ul>	Indoor	+35°F min. -65°F to +200°F
30% Recycled Semi-Gloss	TR	This earth-friendly stock is great when you're looking to go green and reduce consumer waste, while wanting your label to still shine. <ul style="list-style-type: none"> <li>• 30% Post Consumer Waste with a semi-gloss finish</li> </ul>	Indoor	-20°F min. -65°F to +180°F
Brown Kraft	BW	This stock is a favorite for a vintage or natural look and adds texture to the label design. <ul style="list-style-type: none"> <li>• Virgin fiber brown kraft with a water-based rubber resin adhesive</li> <li>• Earth-toned favorite for a "natural look."</li> </ul>	Indoor	+35°F min. -50°F to +140°F
Estate #8 Estate #9	SW ET	These stocks are premium and favorites for labels on products that want to express an upscale brand appearance. <ul style="list-style-type: none"> <li>• Estate #8 has a white vellum face stock and Estate #9 has a cream laid finish paper face stock</li> <li>• Withstands water and moisture without falling apart while the permanent adhesive is removable in a minimum of 100°F water</li> <li>• Poly-coated liner for high-speed machine applications</li> <li>• Excellent for wine, gourmet food and high-end labels</li> </ul>	Indoor	+20°F min. -65°F to +200°F
Chartreuse Fluorescent Green Fluorescent Pink Fluorescent Orange Fluorescent Red Fluorescent	AG I AF AE  C	The bright color of this stock stands out and makes a statement known. <ul style="list-style-type: none"> <li>• Attention-grabbing matte stock suitable for writing on</li> <li>• Black ink is recommended. Colors of this caliber stand quite effectively on their own, wouldn't you agree?</li> </ul>	Indoor	+32°F min. -4°F to +176°F  -20°F min. -65°F to +200°F
White Laser Chartreuse Fluorescent Laser Green Fluorescent Laser Orange Fluorescent Laser Pink Fluorescent Laser Red Fluorescent Laser	L FC FG FN FP FR	<ul style="list-style-type: none"> <li>• Provides consistent processing through laser printers</li> <li>• Permanent acrylic adhesive resistant to high temperatures/melting that may damage printers (which management tends to frown upon)</li> <li>• White stock is also inkjet compatible – how's that for double duty?</li> <li>• Black ink is recommended on Fluorescent stocks</li> </ul>	Indoor	+25°F min. -75°F to +200°F
White Laser Removable	RZ	<ul style="list-style-type: none"> <li>• Uncoated paper stock great for laser &amp; inkjet printers and copiers</li> <li>• Adhesive has long term removability even on cardboard and plastics</li> </ul>	Indoor	+40°F min. -65°F to +180°F

STOCK	STOCK CODE	DESCRIPTION	INDOOR/OUTDOOR	APPLICATION & SERVICE TEMP
<b>White EDP</b> <b>Yellow EDP</b> <b>Ivory EDP</b> <i>(Also known as DSX or Smudge Proof Tractor Feed)</i>	<b>H</b> <b>BV</b> <b>BD</b>	EDP stock is a high-speed option for electronic data processing labels. <ul style="list-style-type: none"> <li>An uncoated, smudge-resistant stock allows for increased print image and toner adhesion</li> <li>Meets high-speed requirements for data processing; pinfed and fanfold finishing available</li> <li>A porous stock (not recommended for screens and fine details)</li> <li>Also available with non-permanent adhesive</li> </ul>	Indoor	+25°F min. -40°F to +300°F
<b>Gold Foil</b> <b>Silver Foil</b>	<b>D</b> <b>E</b>	The shine and texture to this stock adds a prestigious quality to your labels. <ul style="list-style-type: none"> <li>Foil paper stock with a high sheen</li> <li>Visually appealing and elegant - great for embossing and foil stamping</li> <li>Not recommended as a writing surface</li> </ul>	Indoor	-20°F min. -65°F to +160°F
<b>Gold Foil Dull</b> <b>Silver Foil Dull</b>	<b>AI</b> <b>AH</b>	A glamorous, yet subtle stock choice. <ul style="list-style-type: none"> <li>Foil paper stock with a matte sheen</li> <li>Great for embossing and foil stamping</li> </ul>	Indoor	-20°F min. -65°F to +180°F
(BOPP: Biaxially-Oriented Polypropylene) <b>White Film BOPP</b> <b>Clear Film BOPP</b>	<b>WB</b> <b>BJ</b>	When your space calls for more durability than paper, choose this versatile film option. <ul style="list-style-type: none"> <li>High gloss film stock</li> <li>Excellent for curved surface application</li> <li>High tear resistance</li> <li>Water, oil and moisture resistant</li> </ul>	Indoor	+23°F min. -20°F to +212°F
<b>Silver Film BOPP</b>	<b>KR</b>	<ul style="list-style-type: none"> <li>Mirror-like reflectivity</li> </ul>	Indoor	+25°F min. -40°F to +175°F
<b>Clear Window Lite</b> <b>White Window Lite</b>	<b>WC</b> <b>WW</b>	Even though it's in the name, this stock is not just for windows! <ul style="list-style-type: none"> <li>Great alternative to magnets and static cling</li> <li>Repositionable - so you can change things up to your heart's content</li> <li>Clean and easy removal with no adhesive left behind</li> </ul>	Indoor and Outdoor	+35°F min. -40°F to +180°F
<b>Gold Polyester</b> <b>Gold Polyester Brushed</b> <b>Silver Polyester Brushed</b> <i>(Also known as Mylar)</i>	<b>U</b> <b>Z</b> <b>S</b>	<ul style="list-style-type: none"> <li>Durable weather-resistant stock</li> <li>Laminated for added protection and durability</li> </ul>	Indoor and Outdoor	+50°F min. -40°F to +302°F
<b>Silver Polyester</b> <b>Clear Polyester</b>	<b>X</b> <b>Y</b>	<ul style="list-style-type: none"> <li>Durable weather-resistant stock</li> <li>Laminated for added protection and durability</li> </ul>	Indoor and Outdoor	+25°F min. -40°F to +300°F
<b>White Polyolefin</b> <b>Yellow Polyolefin</b>	<b>J</b> <b>V</b>	This stock will allow labels to withstand harsh elements and rigorous applications. <ul style="list-style-type: none"> <li>Flexible, weather-resistant film holds its shape nicely, similar to vinyl</li> <li>Great for sheeted applications</li> <li>Suitable for signage and bumper stickers</li> <li>Laminated for added protection and durability</li> </ul>	Indoor and Outdoor	+10°F min. -40°F to +200°F
<b>White Polyolefin Removable</b>	<b>JR</b>	<ul style="list-style-type: none"> <li>Same great features as White Polyolefin (above)</li> <li>Acrylic based removable adhesive with long-term removability</li> </ul>	Indoor and Outdoor	+50°F min. -40°F to +250°F
<b>Reflective Polyester</b>	<b>SB</b>	<ul style="list-style-type: none"> <li>Retro-reflective stock bounces light back to source</li> <li>Long range scanning up to 45 feet away</li> <li>Great for labeling warehouse racks, pallets, safety vehicles, warnings and permits</li> <li>Imprint will block out reflectivity of stock in that area</li> </ul>	Indoor and Outdoor	+45°F min. -40°F to +300°F

## Labels Adhesives

All labels featured in this catalog, with the exception of Window Lite, are provided with permanent adhesive and cannot be easily removed except with certain solvents. White Gloss Removable, White Laser Removable, White Matte Removable and White Polyolefin Removable will become permanent over time. These stocks do not remove well from paper.

## Label Application

For best results, labels should always be applied at room temperature to smooth, dry, clean, oil-free surfaces. Ink colors will appear transparent on clear stocks. If there is any question as to the proper application, please request samples to test at no charge.

# GLOSSARY

## Adhesive Side Printing

Adhesive side printing offers the option of printing on **BOTH** sides of the label, whether it's the same message or different ones. For example, a label on a clear bottle with a transparent liquid. The front of the label conveys the product's brand information, while the back of the label, viewable through the liquid contents, may serve to communicate ingredients and directions for use. No need for two separate labels! Efficiency at its finest. Not available on removable stock.

## Back Slit

Saving time is all the rage and a back slit speeds up the application process by providing quick release of the liner.

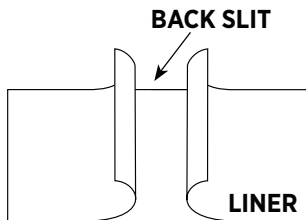

## Backwards Copy

The text or image is printed backwards, allowing the label to be applied on the inside of a window, yet readable from the outside. An option for the sticker placement on windows, such as store fronts or car parking permits.

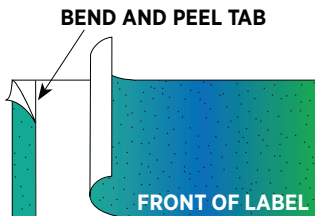

## Bend & Peel

A square cut label with a slit on one end for easier peeling and removal.

## Bleed

A bleed is a printed image that extends to the edge of the label for maximum printing coverage so there's no border or extra white space.

## Copy Position

Also known as the unwind; signifies which direction the copy

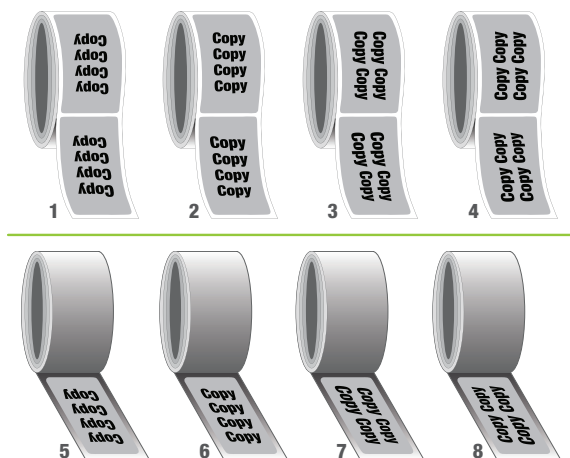

comes off the roll. This is critical for machine applied labels.

## Core Size

Core size refers to the cardboard cylinder that the labels are wrapped around when finished on a roll. Cores come in 1" and 3" diameters, but additional sizes are available upon request.

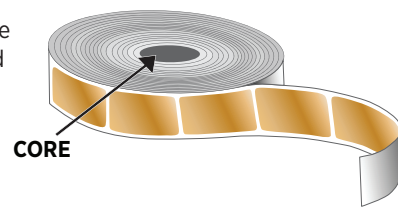

## Draw / Repeat

Refers to the dimension from the top edge of one label to the top edge of the next label.

Length + Gap = Draw / Repeat

See Draw / Repeat diagram on Inside Back Cover.

## Embossing

Embossing involves pressing an image into paper so it is raised above the paper's surface. This raised, or embossed, image subtly stands out on the paperstock, and although ink or foil is not involved, it's an effective way to infuse some prestige into the design.

## Foil Stamping

Foil stamping is the process of imprinting using foil, a die and pressure. The result? A metallic-colored impression that shimmers and shines and captures the eye.

## Flood Coat

Flood coat is the process of applying ink over the entire label to change the color of the stock prior to printing the design.

## freeform™ - Laser Cut

Welcome to the twenty-first century. freeform™ uses a high-powered beam to cut material rather than using a traditional hard die. They can be laser cut into any shape you can think of such as cars, stars, fruits, animals, etc.

## Gap

The space between two labels; 1/8" is standard. See Draw / Repeat diagram on Inside Back Cover.

## High Capacity Rolls

When a large amount of labels is needed, a high capacity roll provides high quality and quantity on a single large roll of labels.

## Kiss Cut

Kiss cut is trade lingo for cutting a label so that the backing sheet remains intact but the sticker waste around the cut image is removed. What's left behind is a unique-shaped label on a larger backing sheet. No fumbling fingers when it comes time to peel off the backing!

## Lamination

- **Gloss Lamination** Our standard gloss lamination enhances appearance while adding a high-gloss sheen that provides weather-resistant protection for our outdoor stocks.
- **Matte Lamination** Matte lamination provides a matte finish with a low-glare surface to enable electronic scanning and offers excellent acid, chemical and oil resistance. It's also the best laminate for handwriting information on your labels.
- **Sunscreen Lamination** Sunscreen lamination is a clear polyester film specifically formatted to protect the label by screening out harmful UV rays. Extends the fade resistance of some inks depending on the environment and usage and provides a high-gloss sheen.

## Liner Side Printing

Also known as backside printing. Copy is printed on the liner of the label. Often used to offer coupons, share business address and hours, promote upcoming events or anything else you'd like to share with your customers.

## Matrix

The stock material surrounding a die cut label. Otherwise known as "what's left when you peel off all the labels,"

## Outside Diameter

Refers to the measurement across the roll of labels at its widest point, including the core.

## Registration

The arrangement of two or more printed images or colors in exact alignment with each other. Perfect registration results in a crisp, clean multi-colored image.

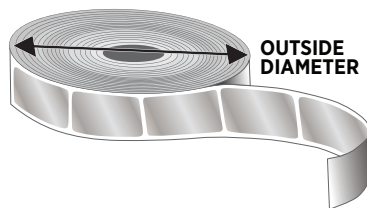

## Reverse

An image where the stock shows through as the imprint. As an example, a white label with black ink would appear as a black label with a white imprint.

## Square Cut Labels

Also known as "Butt Cut," these labels have right angle corners. Each label butts up to the next one on the roll, with no gap and not a shred of unused liner.

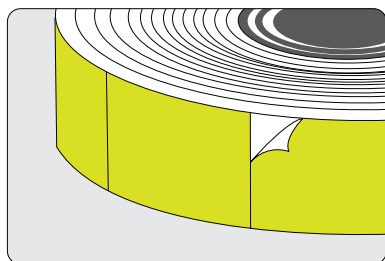

## Variable

Variable printing is a method in which text, graphics and images change from one label to the next, resulting in each label being unique.

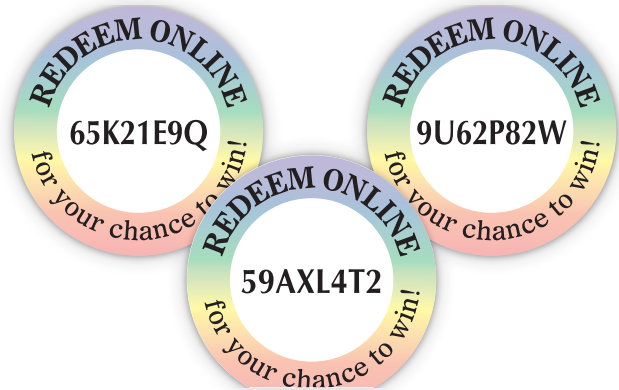

## Varnish

A thin protective coating that is bonded and cured with ultra-violet light. Provides moisture protection but does not provide UV ray protection.

- **Gloss UV Varnish** Leaves a high gloss finish. Not available for matte stocks.
- **Matte UV Varnish** Leaves a no-glare subtle finish.

## White Back-Up

White back-up is the process of applying white ink directly behind the artwork to make it easier to read on clear stocks. See diagram below.

## White Flood Coat

The process of applying white ink across the entire label to make it easier to read on clear stocks, giving it the look of a white label.

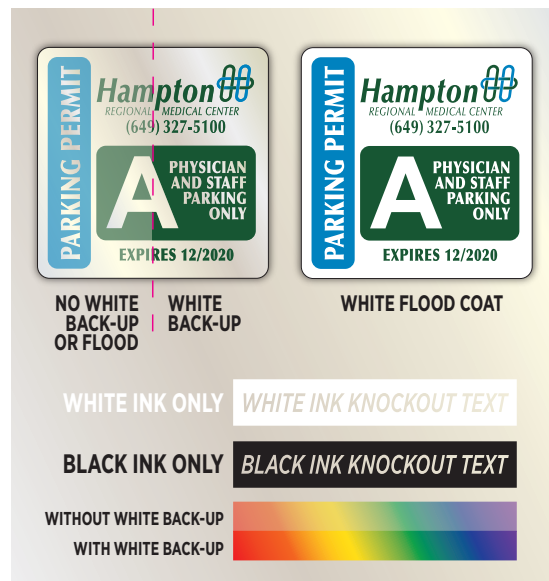

# GUIDELINES & ARTWORK INFORMATION



## We accept art files created in the following applications:

- Acrobat® PDF\*
- Adobe® Photoshop®
- Adobe® Illustrator®
- Adobe® InDesign®



## We do not accept art files created in the following applications:

- Microsoft® PowerPoint®
- Microsoft® Word®
- Microsoft® Excel®
- Microsoft® Publisher®

\*Microsoft® Excel® files only accepted for variable data

**Hold up! We all have standards, and this is no exception!  
Preferred file format is a print-ready PDF. For all artwork, a minimum of 300 DPI is required.**

### Artwork Submission

Send your order and art file(s) to us. Please reference your account number, company name or phone number in the subject line. Remember to note the size, stock, inks and quantity. Submit large artwork files easily via FTP by just compressing the file and upload.

### Bleeds and Borders

- All artwork with a bleed must include a 1/16" extension on all sides to avoid additional charges.
- Artwork with borders should indicate if the border should print 1/16" in from the edge of the label or bleed.

### Cancellations and Changes

Cancellation or changes on orders cannot be guaranteed, so check proof carefully before placing orders. A minimum fee of \$25.00 (V) will be charged for all cancellations or changes. Note that if the order has been printed, the full order value will be charged.

### Creating Your Files

When you're ready to place your order, follow these guidelines to ensure we receive our art files and for the best results:

- Create one item, sized correctly, per document.  
*For freeform™ laser cut labels, create a layered file that includes the cut path.*
- Make sure file(s) are colored correctly.
- Graphics and text should be sized at 100%.
- All supporting graphic file(s) used within your layout must be embedded with your layout file, placed at 100%.

### Order Refusal

Professionalism as a company is important to us, so we reserve the right to refuse to print any labels that we consider profane or immoral.

### Over-Runs

There will be no additional charge for over-runs.

### Photo and Art Authorization

Don't use copyrighted artwork without permission. To avoid legal trouble due to copyright infringement, submit an authorization form with your order.

### Print-Ready Artwork

Print-ready artwork is provided at 100% size, requires no typesetting and has a 1/8" margin on all sides, including a bleed when needed. Please keep the following in mind when preparing print-ready artwork:

- Exact position of text and graphics should be indicated, or we will position using our best judgment.
- File(s) should be colored correctly.
- We have found that photocopies, facsimiles, low-resolution laser prints and pencil or ballpoint sketches don't provide a high enough degree of resolution to produce quality products. For this reason, we ask that you choose another method of providing your artwork.

### Proofs - 1st Proof Free

Proofs are available electronically, as well as by fax. **Please note that the proof needs to be requested when your order is submitted.**

#### Electronic Proofs:

- **SAME DAY** service if received by 12pm CT
- Adds 24-Hour to order production time.
- Additional proofs are \$18.00 (V) each.
- Please provide complete email address or fax number.
- Proof colors will vary by computer and/or printer.  
*(Electronic Proofs only)*
- Stock color will not be represented on the proof.
- Order production time begins after proof approval.

For viewing electronic proofs, please check the Adobe® Reader® or Acrobat® settings under "Edit"/"Preferences"/"Page Display" are as follows:

- Uncheck "Enhance thin lines"
- Set "Use Overprint Preview" to "Always"

### Reprints and Liability

We firmly stand behind our products, and because your complete satisfaction is our highest priority:

- We will gladly and promptly reprint label orders that have defective workmanship.
- We will reprint at no charge if we are at fault.
- Unfortunately, we cannot be held liable for damages that might arise from using our products, other than the replacement cost of such product.

### Reverses

We will reverse your copy free of charge; just indicate on your order what copy is reversed.

### Rights to Promotion

We're proud of the work we do. We reserve the right to use all products in our advertising and displays unless otherwise specified in writing at the time of order.

### Screens and Registration

- Screens are available with a 5%–95% tint.  
*(For example, 85% black is basically dark grey.)*
- Registration of color-to-color is within industry standards of 1/32".



# MACHINE APPLIED LABELS OR BLANK

When ordering machine applied labels, here's what you need to know:

## 1. Copy Position

The copy position (or unwind) signifies which direction the copy comes off the roll; positions 5 through 8 are wound in. Please note horizontal vs. vertical.

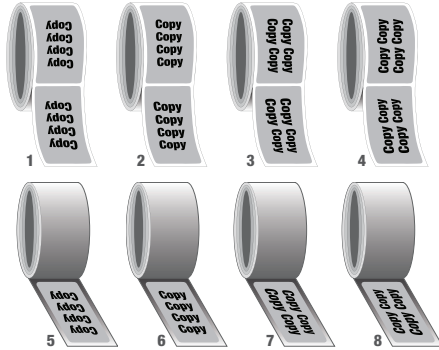

## 3. Core Information

Cores are available in two standard sizes, 1" and 3" in diameter. Cores must be flush with the edge of the roll. Please note the core size and the maximum outside diameter (OD) of the roll when ordering. Additional core sizes are available for an additional charge.

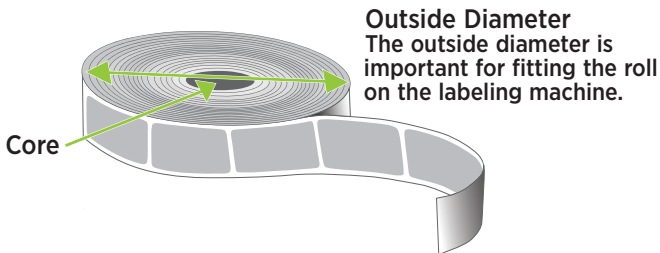

## 2. Draw / Repeat

The draw, or repeat, refers to the distance from the top edge of one label to the top edge of the next label. The length of the label plus the gap equals the repeat. Length + Gap = Draw / Repeat

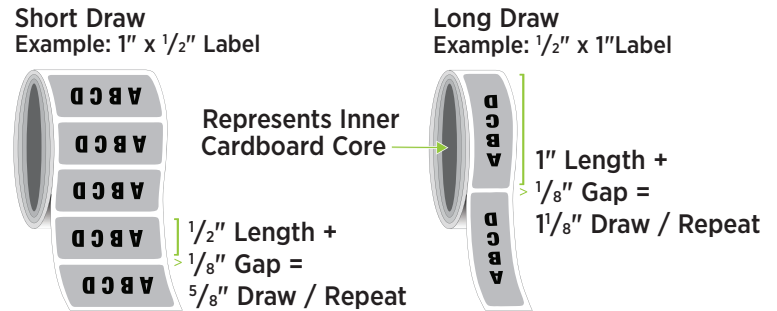

## 4. High Capacity Spooler

Have us spool your labels to cut down on machine stops and restarts to change over new rolls of labels. We can splice together label rolls to create one large roll of non-stop label application. Would you rather have four rolls of 15,000 labels which have to be changed at the completion of each run, or one continuous roll of 60,000 labels? This is what society would call a "no-brainer." If you need this service, give us a call!

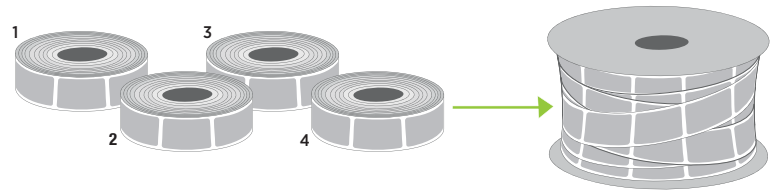

## Questions to ask to ensure the right label for the right application

1. **What is the label being applied to?** *Different surfaces may require specific stocks and/or adhesives.*
2. **What will the label be exposed to?** *A label's environment like water, solvents, abrasives, and temperature can influence its performance so varnishes or laminations may be needed.*
3. **What is the size?**
4. **What is the quantity needed?**
5. **What is the material and ink color(s)?**
6. **Will the label be hand or machine applied?** *Core size, rewind direction, roll outside diameter, number of labels per roll, etc.*
7. **Any special shipping or packaging requirements?** *Drop ship, shrink wrap, quantity per box, outer box labels*



## Fraction/Decimal Conversion Chart

0.0625	-	1/16
0.125	—	1/8
0.1875	—	3/16
0.25	—	1/4
0.3125	—	5/16
0.375	—	3/8
0.4375	—	7/16
0.5	—	1/2
0.5625	—	9/16
0.625	—	5/8
0.6875	—	11/16
0.75	—	3/4
0.8125	—	13/16
0.875	—	7/8
0.9375	—	15/16
1.0	—	1

## Type Point Size Chart

E	E
8pt	9pt
E	E
10pt	11pt
E	E
12pt	14pt
E	E
16pt	18pt
E	E
20pt	22pt
E	E
24pt	28pt
E	E
32pt	36pt
E	E
50pt	55pt
E	E
60pt	65pt
E	E
70pt	72pt

# Who's Using Labels, Stickers and Decals? Everyone!

## Advertising & Promotions

- Service Industries
- Branded Products & Service
- On-Line Companies Packaging

## Associations & Non-Profits

- Charities & Foundations
- Social and Recreational Clubs
- Chambers of Commerce

## Automotive

- Dealerships
- Service & Body Shops
- Rental Car Companies

## Beer & Spirits

- Craft Breweries
- Craft Distilleries & Cider Makers
- Private Labelers

## Cannabis

- Growers
- Processors
- Dispensaries

## E-Cigarettes & Vaporizers

- Manufacturers
- Tobacco & E-Vapor shops
- Distributors

## Education

- Schools & Universities
- Athletic Clubs & Organizations
- Student Clubs

## Financial Services

- Banks and Credit Unions
- Insurance Companies
- Accountants & Tax Advisors

## Food & Beverage

- Bakeries
- Delicatessens
- Restaurants

## Health & Beauty

- Manufacturers
- Promos, Sales & Offers
- Craft Artisans & Marketers

## Hospitality & Conventions

- Hotels & Event Centers
- Event Coordinators
- Visitors Bureaus

## Industrial & Manufacturing

- Warehouses
- Heating & Air Conditioning Businesses
- Shipping & Logistics

## Insurance

- Independent Agents
- Insurance Brokers
- Insurance Services

## Legal

- Law Firms
- Court Systems
- Paralegals

## Media Packaging

- Music Publishers
- Film and Recording Studios
- Packaging Companies

## Medical & Healthcare

- Hospitals, Clinics & Dentists
- Medical Supply Companies
- Home Healthcare

## Political & Campaigns

- Local Races - Mayoral, Sheriff, Judges
- State Campaigns - Governor, Legislative
- Referendums

## Realty & Property Management

- Realtors
- Property Managers
- Title Companies

## Retail

- Manufacturers
- Distributors
- Promos & Sales, Point of Purchase Offers

## Wine

- Wineries
- Corporations
- Private Labelers